

STANDARDGRAPH

Zeichnen und Konstruieren

Drawing and Designing

Dibujar y construir



Standardgraph Zeichentechnik GmbH
D-82538 Geretsried, Spreestr. 27 - 31
Tel. 08171-388 0 • Fax 08171-388 124
www.standardgraph.de • e-mail: info@standardgraph.de

Inhalt	Contents	Contenido	Seite Page Pagina
Flexible Lineale / Dreiecke	Flexible ruler / set squares	Reglas / triángulos flexibles	3 - 7
Allgemein Technisch Zeichnen	General drawing	Dibujo técnico general	5
Maßstäbe / Zeichendreiecke	Rulers / Set squares	Reglas / Escuadras / Escalímetros	8 - 20
Fächermaßstäbe/Typometer	Fan-shaped reduc. scale rulers	Abanico de escalímetros	21
Zeichenplatten	Drawing boards	Tablero de dibujo	22
Zeichenköcher	Telescoping tubes	Tubo telescópico	23
Zeichenmappen	Drawing wallets	Carpetas de dibujo	24
Allgem. Technisch Zeichnen	General drawing	Dibujo técnico general	25 - 33
Elektrotechnik, Elektronik	Electrotechnics, Electronics	Electrotecnica, Electrónica	34 - 36
Stahlbau, Maschinenbau	Construction and Mechanical Engineering	Construcción metálica y de maquinaria	37 - 39
Haustechnik und Vermessung	Domestic Installation Architecture and surveying	Técnica doméstica y topografía	40 - 45
Ausbildung, EDV, Spezialgebiete	Education, data processing and specialized fields	Formación, proceso de datos y especialidades	46 - 50
Schriftschablonen	Lettering guides	Plantilla de letras	50 - 56
Tuschezeichner	Technical pens	Estilógrafos técnicos	57 - 61
Fineliner	Fineliner	Fineliner	62
Tusche	Indian ink	Tintas	62
Trichterfedern	Funnel pens	Plumas de embudo	63
Stano script	Stano script	Stano script	64 - 65
Skizzierstifte	Sketch pen	Portaminas	66 - 67
Feinminenstifte	Mechanical pencils	Portaminas de mina fina	67 - 68
Zirkel	Compasses	Compás	69 - 71
Schneidmatten	Cutting mats	Tapices de corte	72
Klebebänder / Spitzer	Adhesive tapes / Sharpeners	Cintas adhesivas / Sacapuntas	73 - 74

Flexible Lineale / Dreiecke
Flexible rulers / Set Squares
 Reglas / Escuadras de geometría



Art.-No.

Lineal 30 cm
 unzerbrechlich
 aus transparentem Spezialkunststoff
 mit Tuschekante
 25 Stück im Karton

Ruler 30 cm
 unbreakable
 made of special transparent plastic
 with ink edge
 25 pcs packed

Regla 30 cm
 irrombible
 fabricado de plástico transparente especial,
 con borde biselado
 Embaladas por 25 un.

9003F

Lineal 20 cm
 unzerbrechlich
 aus transparentem Spezialkunststoff
 mit Tuschekante
 25 Stück im Karton

Ruler 20 cm
 unbreakable
 made of special transparent plastic
 with ink edge
 25 pcs packed

Regla 20 cm
 irrombible
 fabricado de plástico transparente especial,
 con borde biselado
 Embaladas por 25 un.

9002F

Hypotenuse - 16 cm

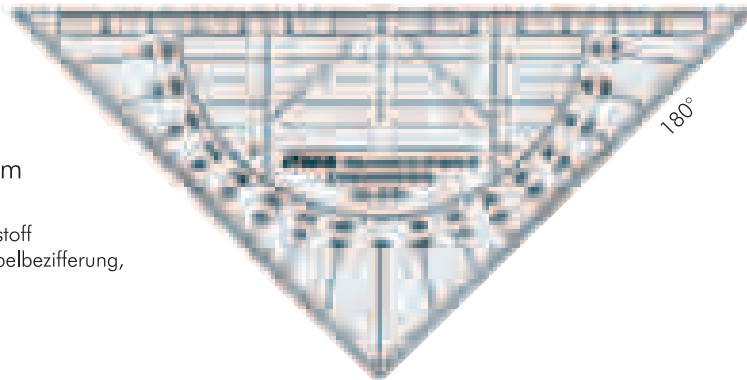

Geometriedreieck 16 cm
 flexibel
 aus transparentem Spezialkunststoff
 Halbkreiswinkelmesser mit Doppelbezeichnung,
 Markierung für Parallelen
 10 Stück gepackt

Geometry set square 16 cm
 flexible
 made of special transparent plastic
 semi-circular protractor with counter
 reading, marks for parallel lines
 10 pcs packed

Escuadra de geometría 16 cm
 irrompible
 fabricado de plástico transparente especial,
 transportador 180° con doble numeración,
 graduación para marcaje de líneas paralelas.
 10 piezas apiñado

9191

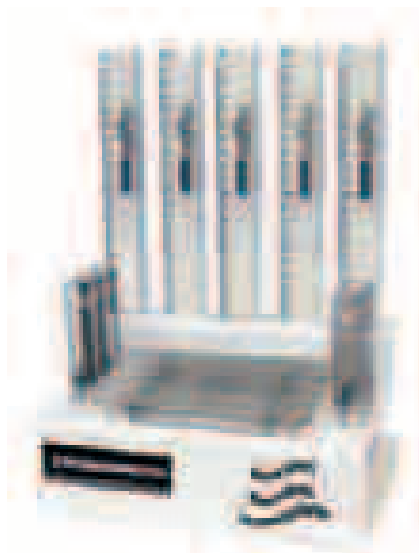

9003FD

Display

30 Lineale 20 cm
 30 Rulers 20 cm
 30 Reglas 20 cm

25 Lineale 30 cm
 25 Rulers 30 cm
 25 Reglas 30 cm

25 Geometriedreiecke 16 cm
 25 Geometry set squares 16 cm
 25 Escuadra de geometría 16 cm

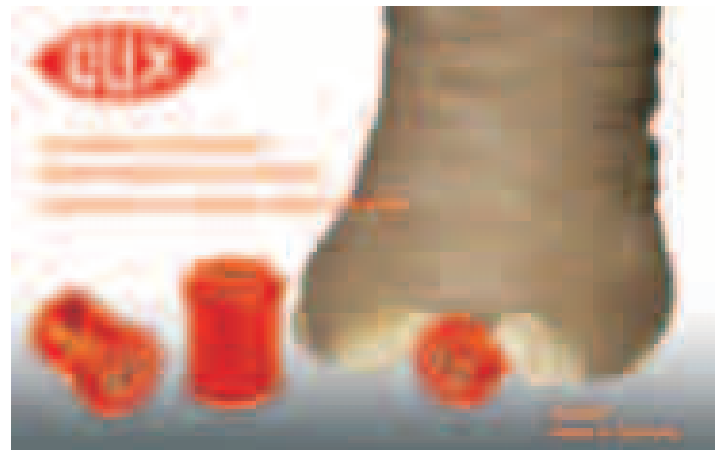

DX5357

bruchfester Dosenspitzer
 shatter resistant box sharpener
 Afilalápices muy resistente a la rotura

Display : 24 Stück
 Display: 24 pcs
 Expositor con 24 sacapuntas

Flexible Lineale / Dreiecke antireflex
Flexible rulers / Set Squares antireflex
Reglas flexibles / Triángulos antirreflejantes



Art.-No.



antireflex - durch Verwendung von speziellem Material gibt es keine störenden Lichtreflexe

antireflex - by using a special plastic material there are no irritating light reflexion

antirreflejantes - la utilización de materiales evita los molestos reflejos de luz

Geometrie-Dreieck 16 cm flexibel - antireflex

aus transparentem Speziakunststoff, Halbkreiswinkelmesser mit Doppelbezeichnung, Markierung für Parallelen
10 Stück im Polybeutel

einzel in Hängetaschen
gepackt zu 10 Taschen

Geometry Set Square 16 cm flexible - antireflex

made of special transparent plastic, semi-circular protractor with counter reading, marks for parallel projection
10 pcs in poly bag

in single hanging bag
10 pcs packed

Escuadra de geometría 16 cm flexibles - antirreflejo

fabricado de plástico transparente especial, Graduación en mm, transportador 180° con doble numeración, graduación para trazar líneas paralelas.
10 piezas en la polibolsa

individual in bolsa colgante
empaque de 10 bolsas

9191FA

9191FAH

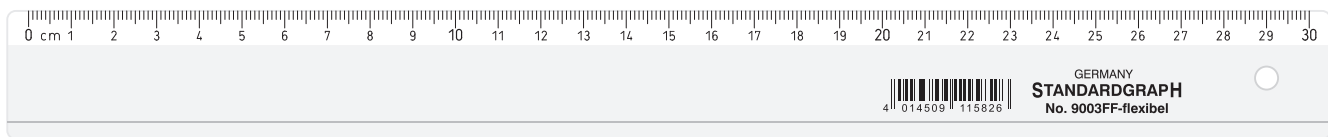

Lineal 30 cm unzerbrechlich - antireflex
aus transparentem Spezialkunststoff, mit Tuschkante
25 Stück im Karton

Ruler 30 cm unbreakable - antireflex
made of special transparent plastic with ink edge
1 carton incl. 25 pcs

Regla 30 cm irrombible - antirreflejo
fabricado de plástico transparente especial, con borde biselado
25 piezas en cartón

9003FA

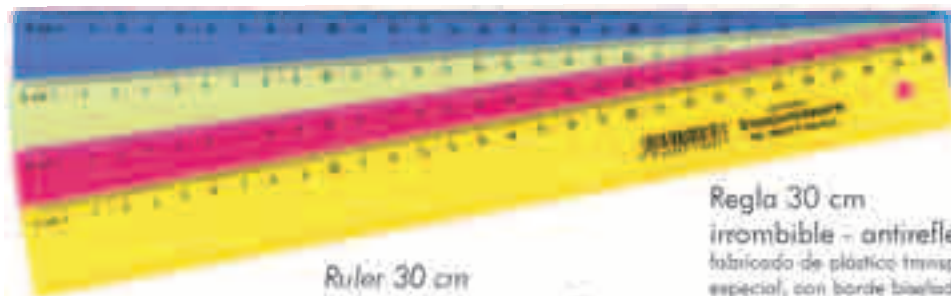

Lineal 30 cm unzerbrechlich - antireflex
aus transparentem Spezialkunststoff, mit Tuschkante
Display mit 60 Stück, farbig sortiert

Ruler 30 cm unbreakable - antireflex
made of special transparent plastic with ink edge
display with 60 pcs, assorted colours

Regla 30 cm irrombible - antirreflejo
fabricado de plástico transparente especial, con borde biselado
Demostración con 60 pcs, colores clasificados



9003FF



Lineal 30 cm - unzerbrechlich
aus recycelbarem Spezialkunststoff, zu 100% kompostierbar, zu 80% aus nachwachsenden Rohstoffen.
25 Stück im Karton

Ruler 30 cm - unbreakable
made of recycleable special plastic, to 100% compostible, to 80% from growing again raw materials.
1 carton incl. 25 pcs

Regla 30 cm - irrombible
fabricado de plástico especial, a 100% compostable, a 80% de materias crudas renovables.
25 piezas en cartón

9003BL

Allgemein Technisches Zeichnen
 General Drawing
 Dibujo técnico general

Art.-No.



Burmester-Kurvenlineale
 3-teilig, 2mm dick
 gepackt zu 20 Stück

Burmester-French Curves
 3-pcs, 2mm thickness
 20 pcs packed

Curvas Burmester
 3-pedazos, 2mm de espesor
 empaquetado a 20 piezas

1123



Einheitsparabel $Y = x^2$
 Sinus-Kosinus-Tangens
 Standard hyperbolic curve $Y = x^2$
 Sine-cosine-tangent
 Parábola universal $Y = x^2$
 para curvas senoidales cosinoidales y tangenciales

20 Stück im Polybeutel/20 pcs in poly bag/20 piezas en la polibolsa

2364

2363

Flexible Lineale / Dreiecke
 Flexible rulers / Set Squares
 Reglas / Triángulos flexibles



9091/D

Hypotenuse - 16 cm



9091

Geometrie-Dreieck 16 cm, flexibler, unzerbrechlicher Kunststoff, farbiger Halbkreiswinkelmesser, gepackt zu 10 Stück, farbig sortiert
 Geometry set square 16 cm, made of flexible unbreakable plastic, 10 pcs packed, assorted colours

Triángulo de geometría 16 cm, plástico flexible e irrompible, medidor de ángulos en color, empaquetado a 10 piezas

9091

Display mit 50 Geometrie-Dreiecken 16 cm, farbig sortiert
 Display with 30 rulers 10 cm, assorted colours
 Expositor con 30 reglas 10 cm, colores surtidos

9091/D

Geometrie-Dreieck 16 cm, flexibler, unzerbrechlicher Kunststoff, einzeln in Hängetasche, gepackt zu 10 Stück,
 Geometry set square 16 cm, made of flexible unbreakable plastic, single poly bag, 10 pcs packed

Triángulo de geometría 16 cm, plástico flexible e irrompible, separado en bolso, empaquetado a 10 piezas

9191



Flexible Lineale / Dreiecke
Flexible rulers / Set Squares
Reglas / Triángulos flexibles

twist & swing

Art.-No.

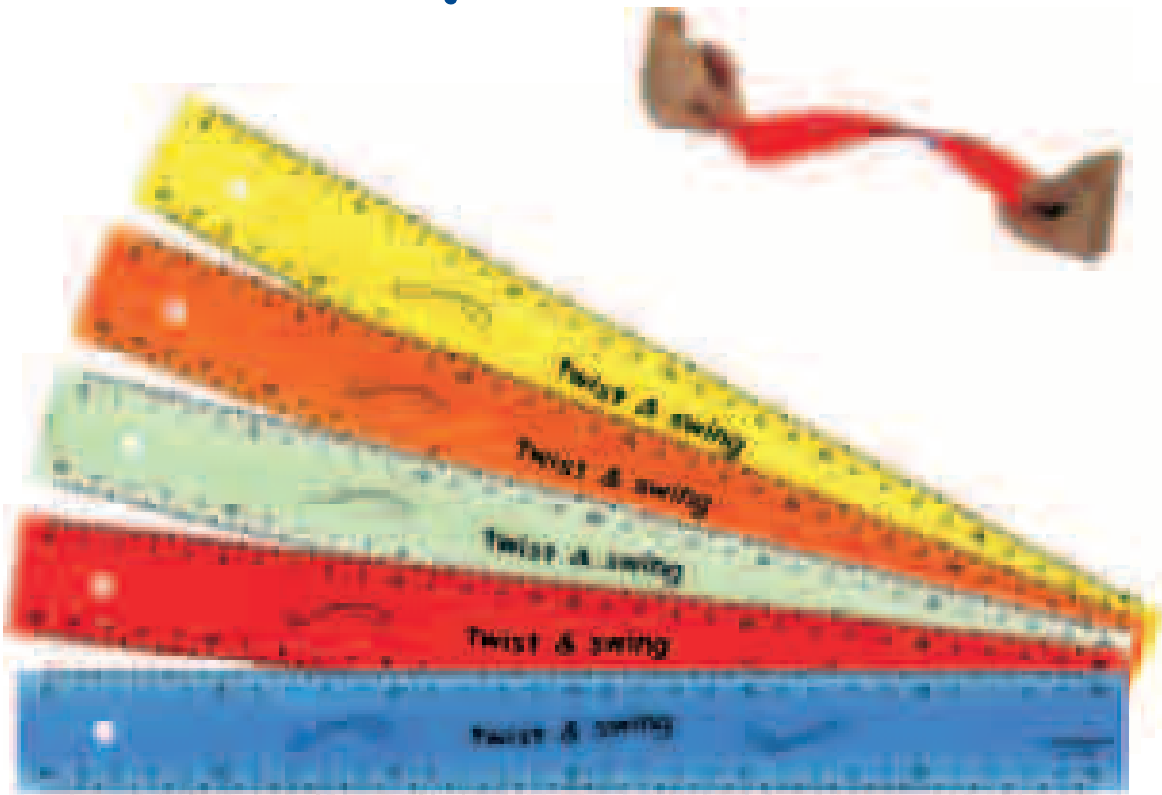

Transparentes, vollkommen flexibles Kunststofflineal 30 cm, farbig sortiert gepackt zu 20 Stück - **PVC-frei**

transparent, total flexible ruler 30 cm made of special plastic, assorted colours 20 pcs packed - **free of PVC**

Regla de plástico flexible y traslúcida, 30 cm, colores surtidos, empaquetado a 20 piezas, **sin PVC**

9040

Beschreibung und VE wie 9040 jedoch **für Linkshänder**

descript. and packaging unity as 9040 only **for lefthanded**

descripción y unidad de embalaje como 9040, **para zurdos**

9040L

Transparentes, vollkommen flexibles Kunststofflineal 15 cm, farbig sortiert gepackt zu 25 Stück - **PVC-frei**

Transparent, total flexible plastic ruler 15 cm, assorted colours 25 pcs packed - **free of PVC**

Regla de plástico flexible y traslúcida 15 cm, colores surtidos, empaquetado a 25 piezas, **sin PVC**

9041



Display mit 30 Linealen 15 cm, farbig sortiert
Display with 30 rulers 15 cm, assorted colours
Expositor con 30 reglas 15 cm, colores surtidos



9041/D

Lineal 20 cm, Beschreibung und VE wie 9041
ruler 20 cm, description and packaging unity like 9041
Regla 20 cm, descripción y unidad de embalaje como en 9041

9042

Display mit 30 Linealen 20 cm, farbig sortiert
Display with 30 rulers 20 cm, assorted colours
Expositor con 30 reglas 20 cm, colores surtidos

9042/D

Flexible Lineale / Dreiecke
Flexible rulers / Set Squares
Reglas / Triángulos flexibles

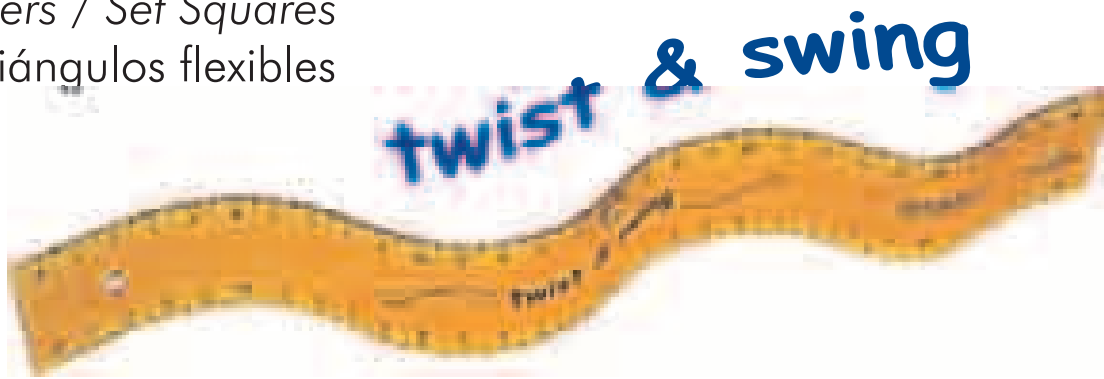

Art.-No.

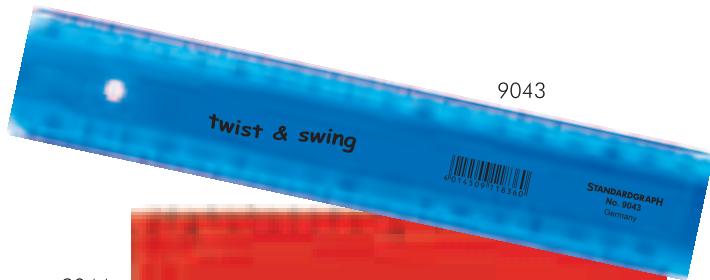

9043

Lineal 17 **cm**, Beschreibung und VE wie 9041
ruler 17 **cm**, description and packaging unity like 9041
Regla 17 **cm**, descripción y unidad de embalaje como en 9041

9043

Display mit 30 Linealen 17 cm, farbig sortiert
Display with 30 rulers 17 cm, assorted colours
Expositor con 30 reglas 17 cm, colores surtidos

9043/D



9044

Lineal 12 **cm**, Beschreibung und VE wie 9041
ruler 12 **cm**, description and packaging unity like 9041
Regla 12 **cm**, descripción y unidad de embalaje como en 9041

9044

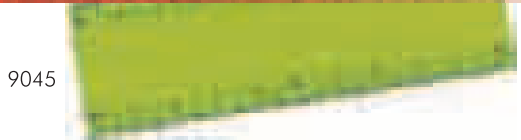

9045

Display mit 30 Linealen 12 cm, farbig sortiert
Display with 30 rulers 12 cm, assorted colours
Expositor con 30 reglas 12 cm, colores surtidos

9044/D



9043/D
9044/D
9045/D

Lineal 10 **cm**, Beschreibung und VE wie 9041
ruler 10 **cm**, description and packaging unity like 9041
Regla 10 **cm**, descripción y unidad de embalaje como en 9041

9045

Display mit 30 Linealen 10 cm, farbig sortiert
Display with 30 rulers 10 cm, assorted colours
Expositor con 30 reglas 10 cm, colores surtidos

9045/D



9099

Display : 20 Lineale 30 cm, 32 St. 15 cm, 20 Geometrie-Dreiecke
Display: 20 rulers 30 cm, 32 pcs 15 cm, 20 Geometry set squares
Expositor con 20 reglas 30 cm, 32 x 15 cm, 20 escuadra de geometría

9099

Maßstäbe/Zeichendreiecke

Rulers/Set Squares

Reglas/Escuadras/Escalímetros

Art.-No.



Lineal für Büro und Ausbildung

Spezialkunststoff mit Tuschefacette an der Linealunterkante
Packung mit 20 Linealen

Ruler for office and education

special synthetic material with ink facet at bottom edge.
Package with 20 rulers

Reglas para oficina y formación

Plástico especial, con borde biselado. Embaladas por 20 un.

	15 cm glasklar/crystal-clear
	15 cm farbig sortiert/assorted colors
	20 cm glasklar/crystal-clear
	20 cm farbig sortiert/assorted colors
	30 cm glasklar/crystal-clear
	30 cm farbig sortiert/assorted colors
	40 cm glasklar/crystal-clear
	40 cm farbig sortiert/assorted colors
	50 cm glasklar/crystal-clear

9001
9001/15
9002
9002/20
9003
9003/30
9004
9004/40
9005



Lineal aus hochwertigem Acrylglas

mit Tuschefacette. Zusätzliche Teilung für
das Zeichnen von Horizontalparallelen

Ruler made from acrylic glass of supreme quality

with ink facet. Additional division for drawing of horizontal parallel lines

Reglas de vidrio acrílico

de alta calidad, con borde biselado y graduación suplementaria
para trazar líneas horizontales.

20 cm 9006
30 cm 9007

Lineal aus hochwertigem Acrylglas. Präzision für höchste Ansprüche. Skalen - Fotogravur, verschleißfrei, Skalengenauigkeit Güteklasse A

Ruler made from acrylic glass of supreme quality. Precision to satisfy highest demands. Photo-engraved scales, wear resistant, accuracy of graduation marks quality grade A

Reglas de vidrio acrílico de alta calidad y extrema precisión. Escalas fotograbadas, resistentes al desgaste. Precisión de las escalas del coeficiente A.

DIN 32851

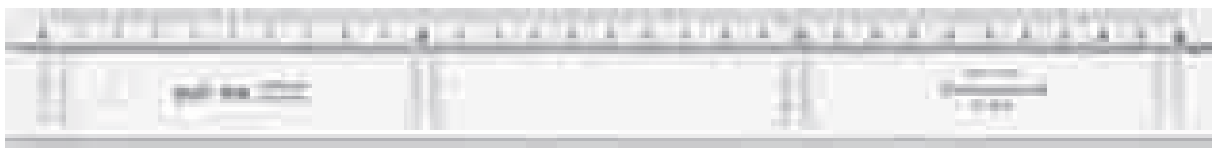

Transparente, nicht reflektierende Facette

1 mm-Teilung, Tuschekante, unterseitige Noppenreihe

Transparent, non-reflecting facet

1 mm-division, ink edge, bottem side row of ink bosses

Faceta transparente, no reflejante

Graduación 1 mm, bisél para tinta china, hilera de puntos realzados en el lado inferior

20 cm 9010
30 cm 9011
40 cm 9012



2 transparente, nicht reflektierende Facetten

1 mm- und 0,5 mm-Teilung, 2 unterseitige Noppenreihen

Two transparent, non-reflecting facets

1 mm- und 0,5 mm-division, two bottem side rows of ink bosses

2 bordes biselados y transparentes, exentos de reflejos

Graduación 1 mm y 0,5 mm, 2 hileras de puntos realzados en el lado inferior.

20 cm 9030
30 cm 9031

Maßstäbe/Zeichendreiecke

Rulers/Set Squares

Reglas/Escuadras/Escalímetros

Art.-No.



Lineal transparent, Facetten beidseitig, Inch- und 1 mm-Teilung, Packung mit 25 Linealen
Ruler transparent, facets on both sides, inch- and metric scale, Package with 25 rulers
Regla transparente, con 2 bordes biselados y escala en mm y pulgadas. Embaladas par 25 un.

30 cm 9093



Lineal transparent, Facetten beidseitig Inch- und 1 mm-Teilung
Ruler transparent, facets on both sides, inch- and metric scale
Regla transparente, con 2 bordes biselados y escala en mm y pulgadas.

30 cm 9094



Prismenmaßstab
 Durchgehende Griffleiste, Kunststoff glasklar, 2 Skalen, mm-Teilung 0 - 300 mm, 150 - 0 - 150 mm
Prism Scale
 Traversing grip ridge, crystal clear, length 2 scales, mm-graduation 0 - 300 mm, 150 - 0 - 150 mm
Regla triangular
 con puno ininterrumpido, cristalina, 2 escalas con graduacion milimétrica 0-300 mm y 150-0-150 mm

30 cm 9100



Holzlineal
 Holzlineal mit Stahleinlage im Maßstabsteil, aus Buchenholz, **unlackiert**
Timber-made Ruler
 Timber made ruler with a steel inlet, **unpolished** beech wood
Reglas de madera
 no barnizada de haya. Con canto de acero en la parte milimetrada.

17 cm 9061
 20 cm 9062
 30 cm 9063
 40 cm 9064
 50 cm 9065

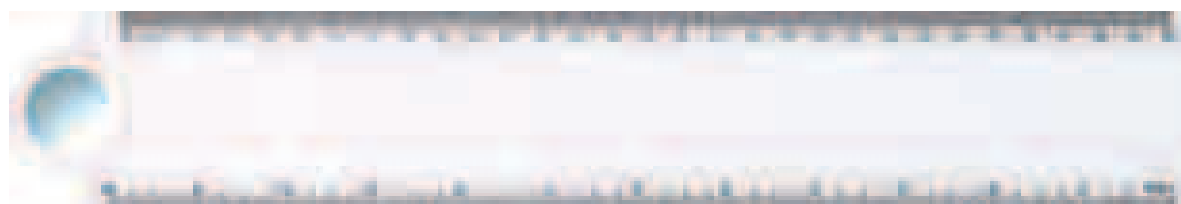

Kunststofflineal mit Vergrößerungslinse 30cm/12 inch
Ruler made of plastic with magnifier lens 30 cm/12 inch
Regla de plástico con lente de aumento 30 cm/12 pulgadas

30 cm/
 12 inch 940530

Maßstäbe/Zeichendreiecke

Rulers/Set Squares

Reglas/Escuadras/Escalímetros

Art.-No.



30 cm 94030
40 cm 94040
50 cm 94050

Aluminium-Lineal Aluminium Ruler Aluminio regla



Reduktionsmaßstab aus Aluminium Skala 1:1/1:20 und 1:25/1:50
Aluminium reduction scale ruler scale 1:1/1:20 and 1:25/1:50
Escalímetro de aluminio Escala 1:1/1:20 y 1:25/1:50

30 cm 940330



30 cm 940430
12 inch

Alu-Maßstab mit durchgehendem Griff, 30 cm/12 inch
Aluminium Scale with traversing grip ridge, 30 cm/12 inch
Escalímetros de aluminio con puño ininterumpido, 30 cm/12 pulgadas



Schneidelineal

mit mm-Teilung, aus silber-
eloxiertem Aluminium mit
schneidfester Edelstahlleinlage und
rutschfester Profilgummiauflage

Cutting Ruler

with mm-graduation, made from silver-
colored anodized aluminium with
cut-proof stainless steel rim and
anti-skid rubber coating

Regla de corte

de aluminio anodizado en color plata,
con escala milimetrada, canto de acero
especial y apoyo antideslizante de
goma perfilada.

30 cm RC 30
40 cm RC 40
50 cm RC 50
70 cm RC 70
100 cm RC 100

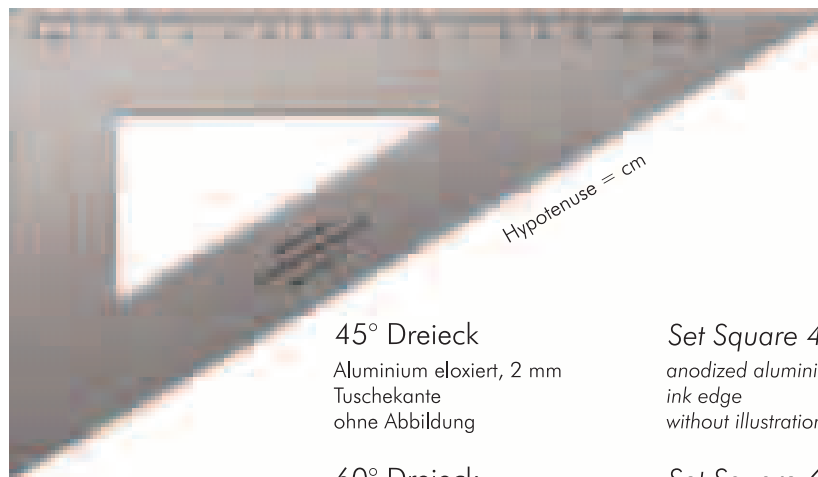

45° Dreieck

Aluminium eloxiert, 2 mm
Tuschekante
ohne Abbildung

Set Square 45°

anodized aluminium, 2 mm
ink edge
without illustration

Escuadra 45°

Aluminio anodizado de 2 mm
Canto para tinta china
sin ilustración

21 cm 96421
32 cm 96432
50 cm 96450

60° Dreieck

Aluminium eloxiert, 2 mm
Tuschekante

Set Square 60°

anodized aluminium, 2 mm
ink edge

Cartabón 60°

Aluminio anodizado de 2 mm
Canto para tinta china

21 cm 96621
32 cm 96632
50 cm 96650

Maßstäbe/Zeichendreiecke

Rulers/Set Squares

Reglas/Escuadras/Escalímetros

Art.-No.

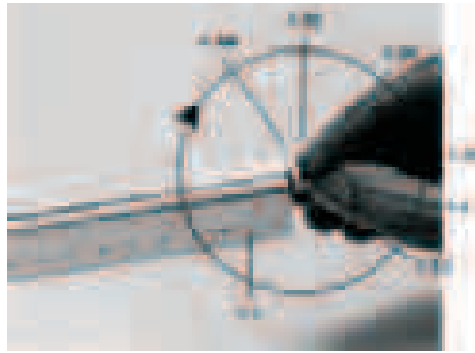
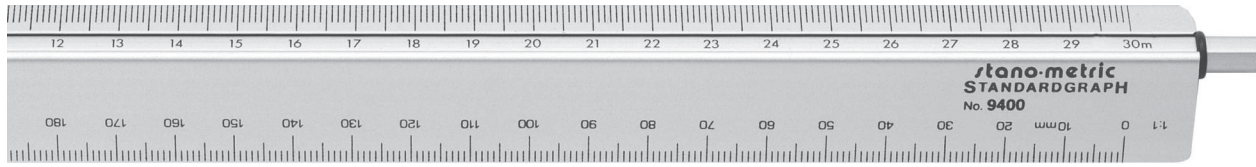

stano•metric Aluminium-Reduktionsmaßstab "INGENIEUR DIN"
Maßstabswechsel durch axiales Drehen des Sechskant-Profilkörpers

stano•metric Aluminium Reduction Scale "ENGINEER DIN"
scales interchangeable by spin of hexagon body

stano•metric Escalímetros de aluminio "INGENIERO DIN"
Cambio de escala mediante rotación axial del cuerpo hexagonal

1:2,5 - 1:5 - 1:10 - 1:20 - 1:50 - 1:100

30 cm **9400**

stano•metric Aluminium-Reduktionsmaßstab "ARCHITEKT"
Maßstabswechsel durch axiales Drehen des Sechskant-Profilkörpers

stano•metric Aluminium Reduction Scale "ARCHITECT"
scales interchangeable by spin of hexagon body

stano•metric Escalímetros de aluminio "ARQUITECTO"
Cambio de escala mediante rotación axial del cuerpo hexagonal

1:20 - 1:25 - 1:50 - 1:75 - 1:100 - 1:125

30 cm **9401**

stano•metric Aluminium-Reduktionsmaßstab "SCHULE"
Maßstabswechsel durch axiales Drehen des Sechskant-Profilkörpers

stano•metric Aluminium Reduction Scale "SCHOOL"
scales interchangeable by spin of hexagon body

stano•metric Escalímetros de aluminio "ESTUDIANTE"
Cambio de escala mediante rotación axial del cuerpo hexagonal

1:20 - 1:25 - 1:33 1/3 - 1:50 - 1:75 - 1:100

30 cm **9402**

stano•metric Aluminium-Reduktionsmaßstab "VERMESSUNG"
Maßstabswechsel durch axiales Drehen des Sechskant-Profilkörpers

stano•metric Aluminium Reduction Scale "SURVEYING"
scales interchangeable by spin of hexagon body

stano•metric Escalímetros de aluminio "AGRIMENSURA"
Cambio de escala mediante rotación axial del cuerpo hexagonal

1:500 - 1:1000 - 1:1250 - 1:1500 - 1:2000 - 1:2500

30 cm **9403**

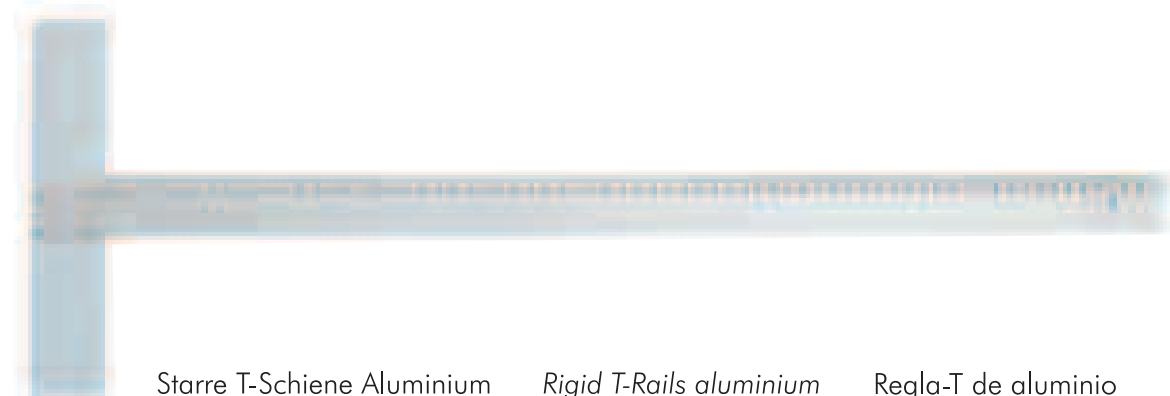

Starre T-Schiene Aluminium
cm-Skala und Tuschkante





Rigid T-Rails aluminium
sm-Scale and ink edge

Regla-T de aluminio
Escala y canto para tinta china

50 cm **TA50**
70 cm **TA70**
100 cm **TA100**
150 cm **TA150**

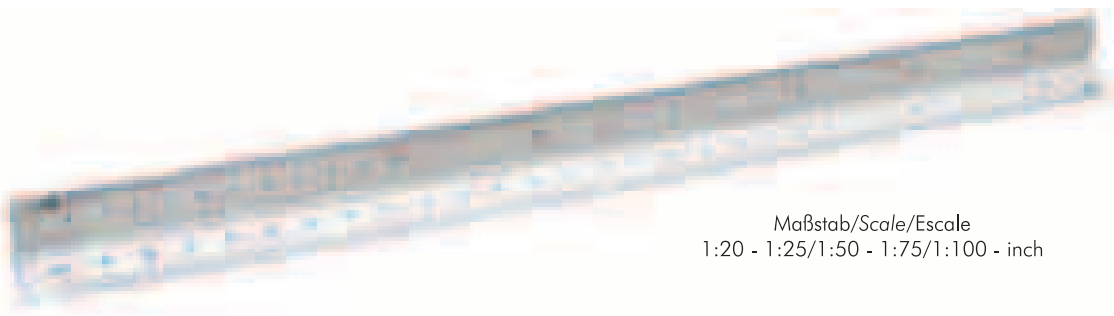
Maßstäbe/Zeichendreiecke
 Rulers/Set Squares
 Reglas/Escuadras/Escalímetros

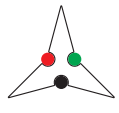
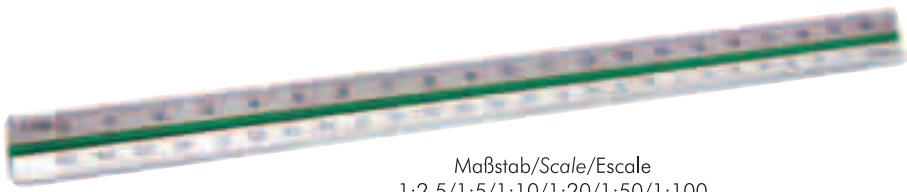
Art.-No.

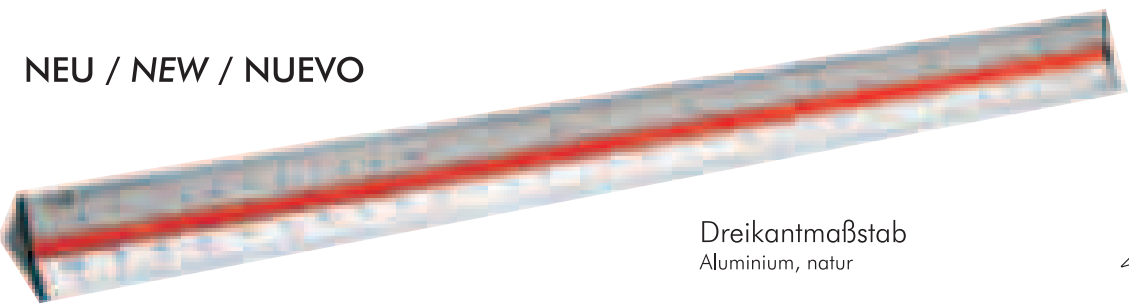
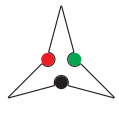
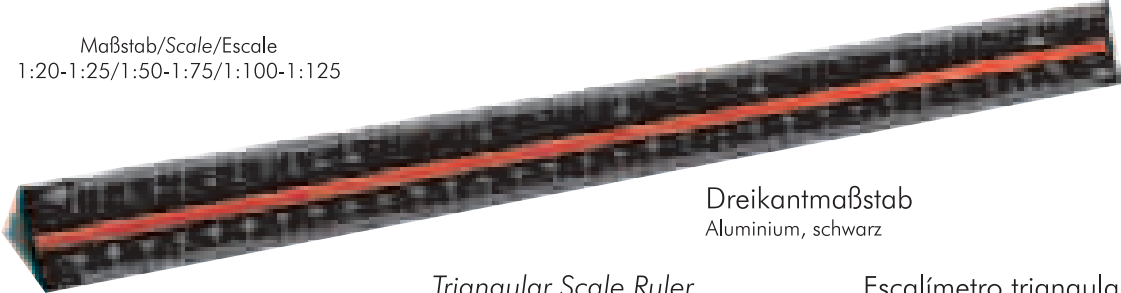
 <p>Dreikantmaßstab Aluminium, natur</p>	<p><i>Triangular Scale Ruler</i> Aluminium, nature</p>	<p>Maßstab/Scale/Escale 1:20 - 1:25/1:50 - 1:75/1:100 - inch</p>  <p>Escalímetro triangulares Alumino, en especie</p>	<p>30 cm 9405</p>
 <p>Dreikantmaßstab Aluminium, silber eloxiert</p>	<p><i>Triangular Scale Ruler</i> Aluminium, silver anodized</p>	<p>Maßstab/Scale/Escale 1:2,5/1:5/1:10/1:20/1:50/1:100</p>  <p>Escalímetro triangulares Alumino anodizado en color plata</p>	<p>15 cm 9405-15</p>
 <p>Dreikantmaßstab Aluminium, silber eloxiert</p>	<p><i>Triangular Scale Ruler</i> Aluminium, silver anodized</p>	<p>Maßstab/Scale/Escale 1:2,5/1:5/1:10/1:20/1:50/1:100</p>  <p>Escalímetro triangulares Alumino anodizado en color plata</p>	<p>20 cm 9405-20</p>
<p>NEU / NEW / NUEVO</p>  <p>Dreikantmaßstab Aluminium, natur</p>	<p><i>Triangular Scale Ruler</i> Aluminium, nature</p>	<p>Maßstab/Scale/Escale 1:20-1:25/1:50-1:75/1:100-1:125</p>  <p>Escalímetro triangulares Alumino, en especie</p>	<p>30 cm 9411-AN</p>
 <p>Dreikantmaßstab Aluminium, schwarz</p>	<p><i>Triangular Scale Ruler</i> Aluminium, black</p>	<p>Escalímetro triangulares Alumino, negro</p>	<p>30 cm 9411-AS</p>

Maßstäbe/Zeichendreiecke
 Rulers/Set Squares
 Reglas/Escuadras/Escalímetros

Art.-No.

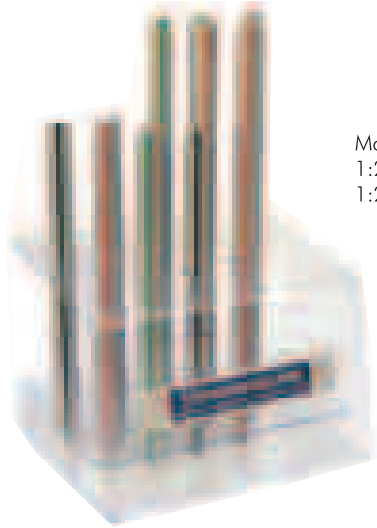

Maßst. / Scale / Escala
 1:2,5 - 1:5 - 1:10
 1:20 - 1:50 - 1:100

Display
 Aluminium-Dreikantlineale
 6 Stück 15 cm
 6 Stück 20 cm

Display
 Aluminium
 Triangular Scale Ruler
 6 pcs 15 cm
 6 pcs 20 cm

Display
 Escalímetros triangulares
 de aluminio
 6 pz 15 cm
 6 pz 20 cm

leeres Display für 12 Dreikantlineale 30 cm/Kunststoff,
 individuell mit verschiedenen Dreikantmaßstäben befüllbar

empty display for 12 triangular scale rulers 30 cm
 made of plastic, individually equippable

Expositor vacío, por 12 escalímetros 30 cm,
 se puede llenar con varios modelos
 de escalímetros triangulares



Dreikantlineale aus Kunststoff - 15 cm
 12 Stück im Display

Triangular Scale Ruler 15cm, made of plastic
 Display contains 12 pcs

Escalímetros triangulares 15 cm, de plástico
 12 pz el display



Maßst. / Scale / Escala
 1:10/100 - 1:20/200 - 1:25/250
 1:30/300 - 1:40/400 - 1:50/500

9405D

9410D

9410-15

Maßstäbe/Zeichendreiecke

Rulers/Set Squares

Reglas/Escuadras/Escalímetros

Art.-No.

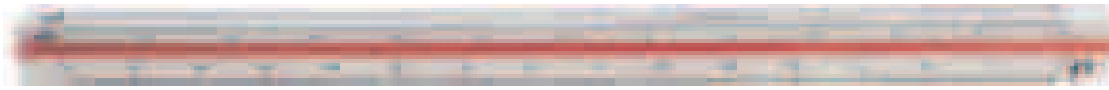

Dreikantmaßstäbe

aus weißem Kunststoff mit drei farbigen Hohlkehlen und markanter großer Vorbezifferung, in transparentem Kunststoffetui.
Für Ingenieur, Architekt, Vermessung und Berufsschule

Triangular Reduction Scales

made from white synthetic material with three colored grooves and prominent large-sized predigits. In a see-through plastic wallet.
For engineers, architects, surveying and technical schools.

Escalímetros triangulares

Hechos de plástico blanco con 3 gargantas coloreadas, con numeración destacante.
Estuche de plástico transparente. Para ingenieros, arquitectos, topografía y formación profesinal.

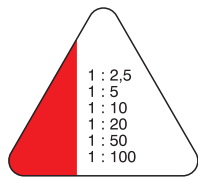

ingenieur
engineers **9410**
ingeniero

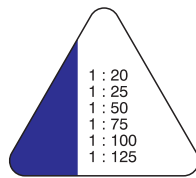

architect
architects **9411**
arquitecto

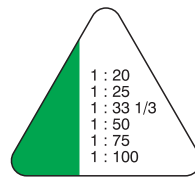

berufsschule
technical schools **9412**
formación profesional

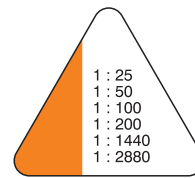

vermessung
surveying **9413**
topografía

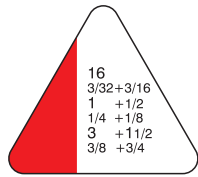

Zoll / Inch **9414**

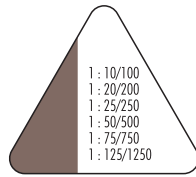

vermessung
surveying **9416**
topografía

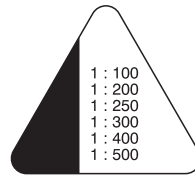

architect
architects **9418**
arquitecto

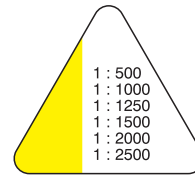

vermessung
surveying **9419**
topografía

30 cm

9410
9411
9412
9413
9414
9416
9418
9419

Starre T-Schiene Acrylglas

geklebter Kopf, Tuschekanten und Facette

Rigid T-Rails

glued fitted head, ink edges and facets



Regla-T de vidrio acrílico
con T pegada y bordes biselados

50 cm
65 cm
80 cm
100 cm

T0F
T1F
T2F
T3F

Flexibles Kurvenlineal mit mm-Teilung

Flexible curve Ruler with mm-graduation

Regla flexible para curvas con mm-graduation



30 cm
40 cm
50 cm

95030
95040
95050

Maßstäbe/Zeichendreiecke
Rulers/Set Squares
Reglas/Escuadras/Escalímetros



Vollkreis-Winkelmesser 360°/0,5°
für Schule und Ausbildung mit gegenläufiger Bezifferung,
Ø 15 cm mit Tuschefacette, farbige transparent, Dicke 2 mm,
(gepackt zu 10 Stück)

Full Circle Protractor 360°/0,5°
for school and education with counter reading, transparent tinted
Ø 15 cm with ink facet, thickness 2 mm, (package with 10 pcs.)

Goniómetro de círculo entero 360°/0,5°
para colegio y formación, con escalas opuestas, de color transparente
Ø 15 cm, espesor 2 mm con borde biselado, (embalados por 10 un.)

Art.-No.
Ø15 cm **9600/15**

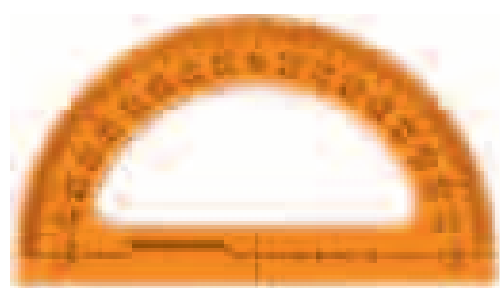

Halbkreis-Winkelmesser 180°/1°
für Schule und Ausbildung mit gegenläufiger Bezifferung
Ø 10 cm Kunststoff, 1 mm farbige transparent (verpackt zu 10 Stück)

Semi-circular Protractor 180°/1°
for school and education with counter reading
Ø 10 cm, thickness 1 mm transparent tinted (Package with 10 pcs.)

Goniómetro de semicircula 180°/1°
para colegio y formación, con escalas opuestas, de color transparente
Ø 10 cm, espesor 1 mm (embalados por 10 un.)

Ø10 cm **9700/10**



Zeichendreieck mit Winkelmesser
15 cm/1 mm, 180°/1°, Kunststoff glasklar, Hypotenuse 210 mm,
Dicke 2 mm

Set Square with protractor
15 cm/1 mm, 180°/1°, plastic, transparent, hypotenuse 210 mm,
thickness 2 mm

Escuadra con transportador
15 cm/1 mm, 180°/1°, plástico cristalino, hipotenusa 210 mm,
espesor 2 mm

15 cm **9149**



Kursdreieck
180°/1°, Teilung 3200 (50), 20 cm/1 mm (10-0-10), Hypotenuse 265 mm,
Dicke 2 mm aus Kunststoff glasklar mit Kunststoffgriff

Navigation Set Square
180°/1° and 3200 (50), 20 cm/1 mm (10-0-10), hypotenuse 265 mm,
plastic transparent, thickness 2 mm with raised plastic grip

Transportador náutico
180°/1° y 3200 (50), 20 cm/1 mm (10-0-10), hipotenusa 265 mm,
espesor 2 mm, con puño de plástico

20 cm **9180**

Maßstäbe/Zeichendreiecke
 Rulers/Set Squares
 Reglas/Escuadras/Escalímetros

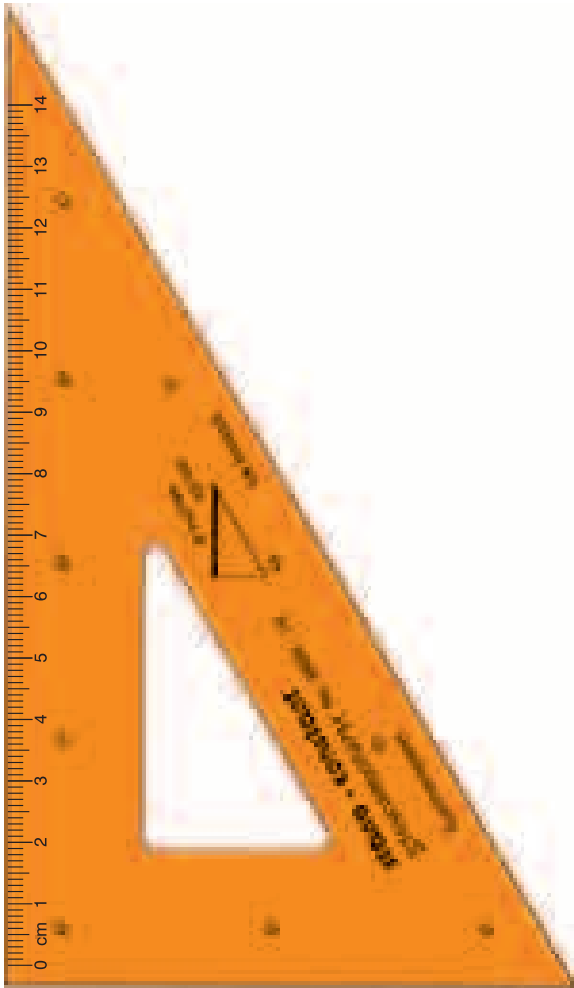

Zeichendreiecke "CONSTANT"

Ausführung 45°
 Acrylglas, 2mm, transparent orange, mm-Maßstab an den Katheten
 Länge der Hypotenuse in cm

Set Squares "CONSTANT"

Version 45°
 acylic glas, 2mm, orange transparent, mm-graduation on cathetus sides
 Length of hypotenuse/cm

Escuadras "CONSTANT"

Cartabón 45°
 Vidrio acrílico transparente de color naranja, 2mm. Escalas milimétricas en los catetos.
 Largo de la hipotenusa en cm.

Ausführung 60°

Acrylglas, 2mm, transparent orange, ohne mm-Teilung
 Länge der großen Kathete in cm

Version 60°

acylic glas, 2mm, orange transparent, without mm-graduation
 Length of longer cathetus/cm

Cartabón 60°

Vidrio acrílico transparente de color naranja, 2mm. Sin escalas milimétricas.
 Largo del cateto mayor en cm.

Art.-No.



16 cm	9645/16
20 cm	9645/20
25 cm	9645/25
30 cm	9645/30
35 cm	9645/35
40 cm	9645/40
50 cm	9645/50



16 cm	9660/16
20 cm	9660/20
25 cm	9660/25
30 cm	9660/30
35 cm	9660/35
40 cm	9660/40
50 cm	9660/50

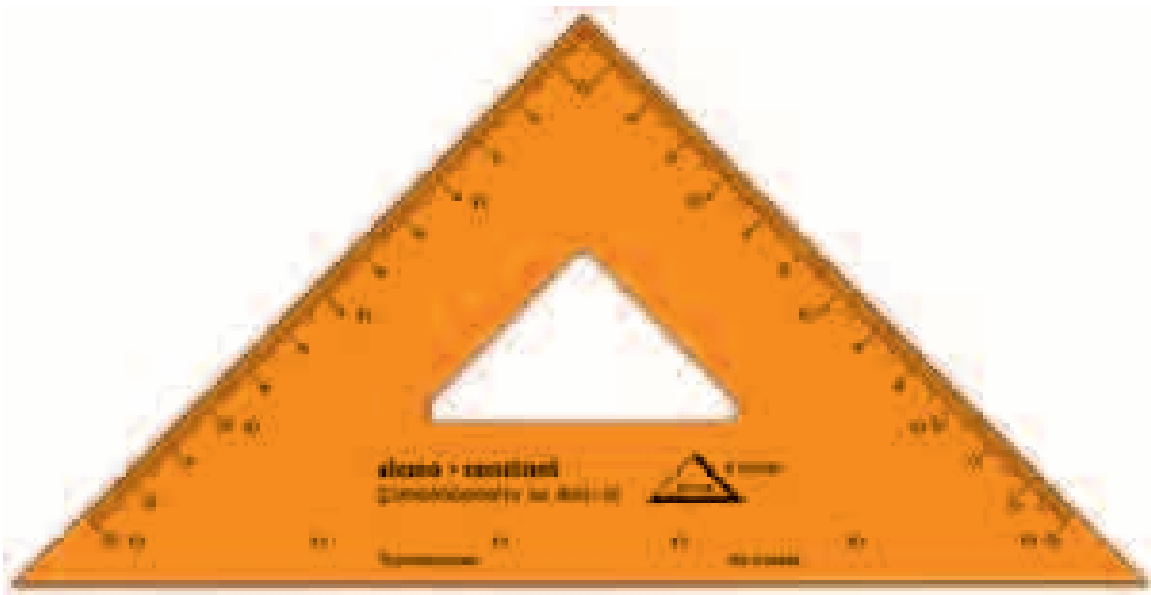

Maßstäbe/Zeichendreiecke
Rulers/Set Squares
Reglas/Escuadras/Escalímetros

Art.-No.

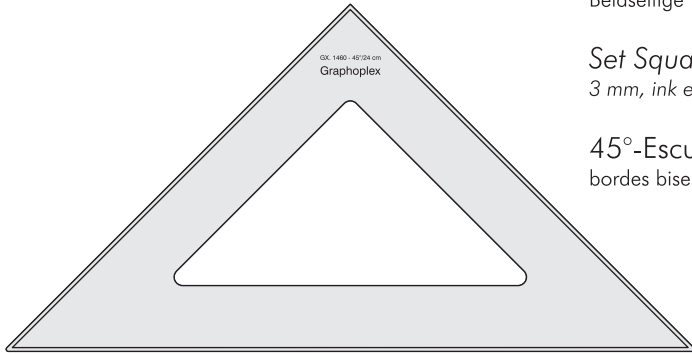

45°-Dreieck Acryl-Glas
Beidseitige Tuschekante, 3 mm stark

Set Square 45° acrylic glass
3 mm, ink edges on both sides

45°-Escuadras de vidrio acrílico
bordes biselados, 3 mm

Kathete	Hypotenuse
9 cm	12,6 cm
14 cm	19,7 cm
19 cm	26,8 cm
24 cm	33,9 cm
29 cm	40,9 cm
34 cm	48,0 cm



GX143
GX144
GX1450
GX1460
GX1470
GX1480

60°-Dreieck Acryl-Glas
Beidseitige Tuschekante, 3 mm stark

Set Square 60° acrylic glass
3 mm, ink edges on both sides

60°-Escuadras de vidrio acrílico
bordes biselados, 3 mm

Kathete	Hypotenuse
19 cm	21,8 cm
24 cm	27,6 cm
29 cm	33,4 cm
34 cm	39,2 cm
39 cm	45,0 cm
15 cm	17,4 cm



GX160
GX1610
GX1620
GX1630
GX1640
GX175

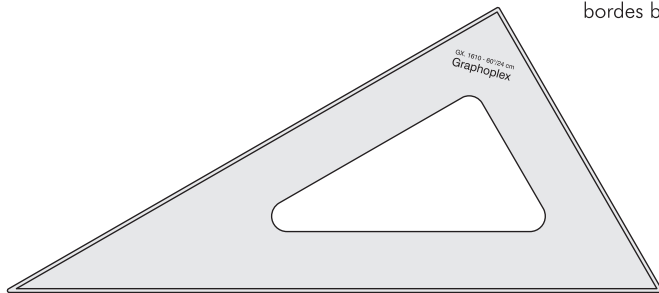

257 x 198 mm



Architekt-Kombi

Acrylglas, 2mm, glasklar transparent, schlagzäh, 45°- und 60°-Dreieck kombiniert, mit Facette an den Außenkanten, Skalen 1:1, 1:20, 1:25, 1:50 und 0,5:1

All-purpose combined set square
for architects

acrylic glass, 2mm, crystal-clear, transparent, shock-proof, combined 45°- and 60°-set squares with facets on the outer edges, scales 1:1, 1:20, 1:25, 1:50 and 0,5:1

Escuadra combinada para arquitectos

de vidrio acrílico 2mm, transparente y resistente a choques, combinación 45° y 60°, con bordes biselados, escalas 1:1, 1:20, 1:25, 1:50 y 0,5:1



0,5

9300

Maßstäbe/Zeichendreiecke
Rulers/Set Squares
Reglas/Escuadras/Escalímetros

Art.-No.

Hypotenuse - 16 cm

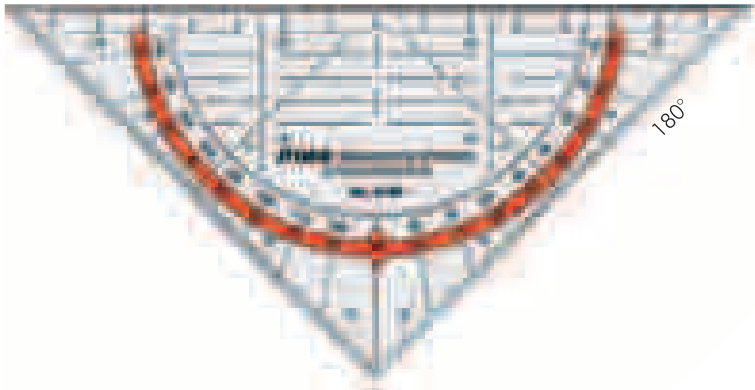

stano Geometrie-Dreieck
Kunststoff glasklar Kombizeichengerät für die Schule, mm-Teilung, Halbkreiswinkelmesser mit Doppelbezeichnung, (eine Skala farbig unterlegt), Markierungen für Parallelen

stano Geometry Set Square
plastic transparent all-purpose drawing instrument for school, mm-graduation, semi-circular protractor with counter reading (one scale with colored background), marks for parallel projection

Escuadra de geometría Stano
plástico cristalino, instrumento combinado de dibujo para el colegio. Graduación en mm, transportador 180° con doble numeración (escala coloreada), graduación para trazar líneas paralelas. Con biseles.

16 cm
D

9190

Hypotenuse - 16 cm

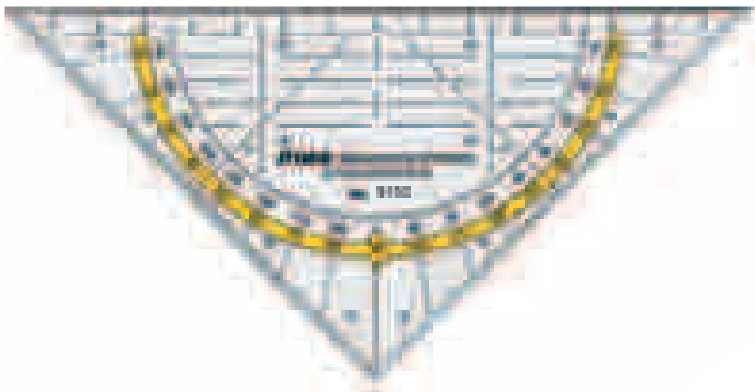

stano Geometrie-Dreieck
aus Kunststoff glasklar, Beschreibung wie 9190, Skala farbig unterlegt, einzeln in Hängetasche, gepackt zu **20 Stück**

stano Geometry Set Square
plastic transparent, description as 9190, one scale with colored background, single poly bag, **20pcs packed**

Escuadra de geometría Stano
de plástico cristalino. Descripción: véase art. 9190 (escala coloreada), separado en bolso empaquetado a **20 piezas**

16 cm
D

9192

stano Geometrie-Dreieck
aus Kunststoff glasklar, Beschreibung wie 9190, Skala farbig unterlegt, verpackt zu **50 Stück im Karton**

stano Geometry Set Square
plastic transparent, description as 9190, one scale with colored background, **50 pcs packed in carton**

Escuadra de geometría Stano
de plástico cristalino. Descripción: véase art. 9190 (escala coloreada), **50 piezas en cartón**

16 cm
D

9193

Hypotenuse - 16 cm

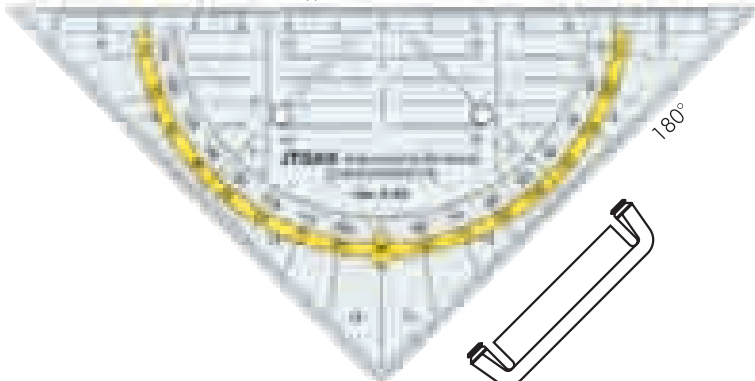

stano Geometrie-Dreieck
aus Kunststoff glasklar, Beschreibung wie 9190 jedoch mit **abnehmbarem Griff**

stano Geometry Set Square
plastic transparent, description as 9190, but with **detachable grip**

Escuadra de geometría Stano
de plástico cristalino. Descripción: véase art. 9190 pero con **asidero amovible**.

16 cm
D

9194

Maßstäbe/Zeichendreiecke Rulers/Set Squares Reglas/Escuadras/Escalímetros

Art.-No.

Zeichendreieck
für den TZ-Unterricht
Kunststoff glasklar, mit festem Griff,
Winkelskala 180°/1° mit gegenläufiger
Bezifferung (eine farbig unterlegt)
Rasterlinien, mm-Teilung mit mittigem Nullpunkt

Set Square
for technical drawing training, made from crystal-clear plastic
with grip, degree deviation 180°/1° with counter reading
(one scale colored background), mm-graduation
with zero-center, marks for parallel projection

Escuadra de geometría
para la enseñanza técnica, de plástico cristalino. Con asidero,
líneas de trama, graduación 180°/1° en los catetos con doble
numeración (escala coloreada),
escala milimétrica con punto zero central.

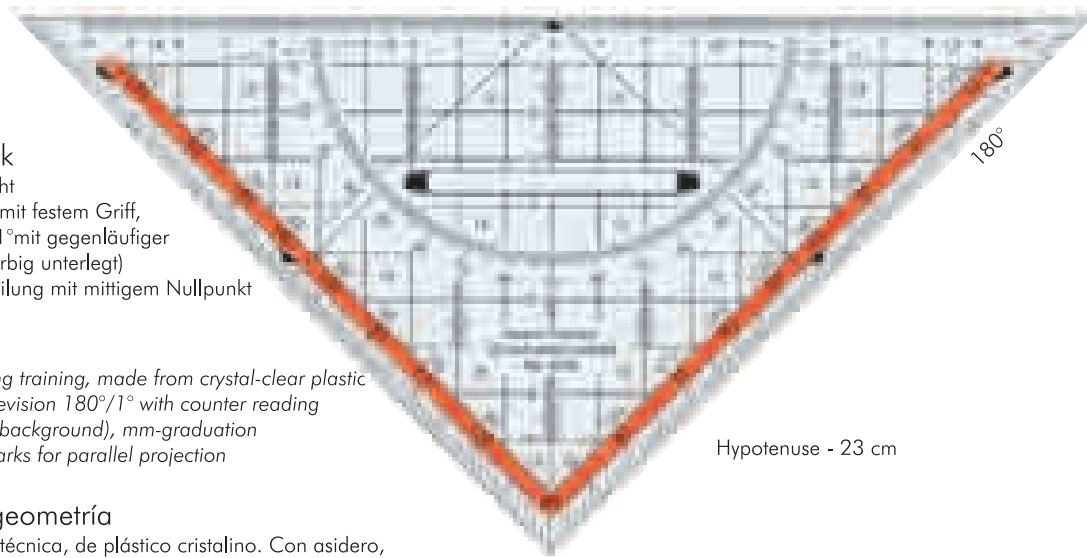

23 cm

9200



Zeichendreieck (200°) ohne Abbildung
Beschreibung wie 9200, Teilung 200°,
Set Square (200°) without illustration
description as 9200, Centesimal measure 200°,
Escuadra (200°) sin ilustración
Descripción como art. 9200

Zeichendreieck
Beschreibung wie 9200, 180°, jedoch mit abnehmbarem Griff,
Set Square
description as 9200, 180° but with detachable grip
Escuadra
Descripción como art. 9200, 180° pero con asidero amovible

23 cm

9201

23 cm

9202

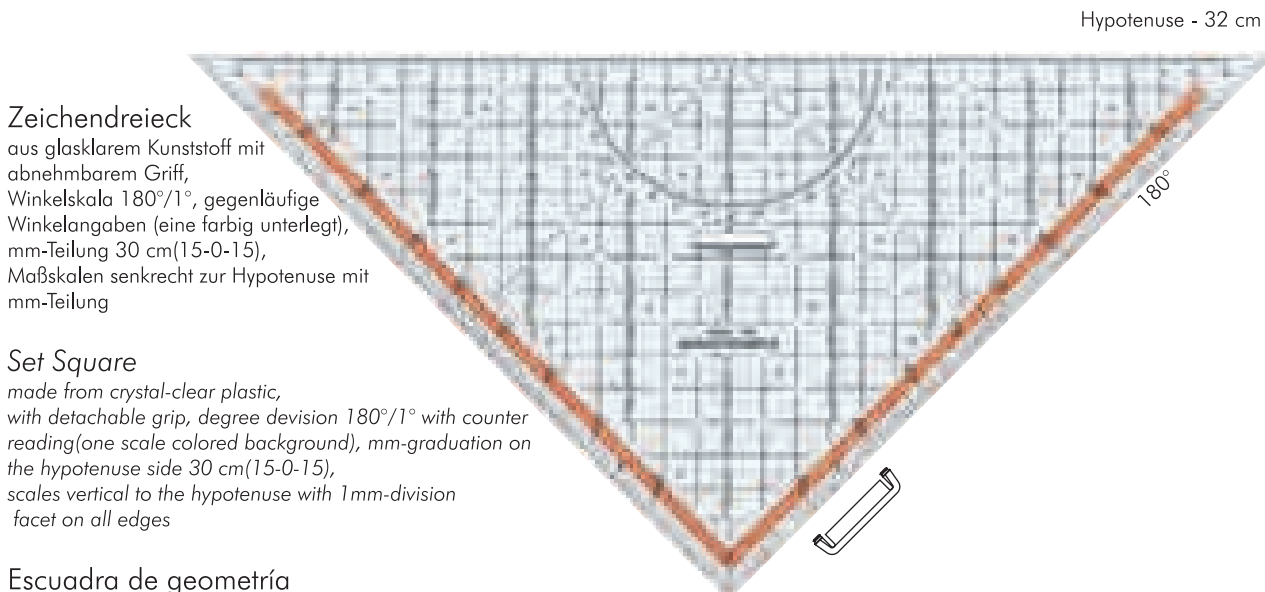

Zeichendreieck
aus glasklarem Kunststoff mit
abnehmbarem Griff,
Winkelskala 180°/1°, gegenläufige
Winkelangaben (eine farbig unterlegt),
mm-Teilung 30 cm(15-0-15),
Maßskalen senkrecht zur Hypotenuse mit
mm-Teilung

Set Square
made from crystal-clear plastic,
with detachable grip, degree deviation 180°/1° with counter
reading(one scale colored background), mm-graduation on
the hypotenuse side 30 cm(15-0-15),
scales vertical to the hypotenuse with 1mm-division
facet on all edges

Escuadra de geometría
de material sintético cristalino, con asidero amovible,
con escalas opuestas de ángulos 180°/1° sobre fondo de color. Escala graduada
en la hipotenusa 30 cm(15-0-15), y escalas graduadas de 1mm perpendicular
a la hipotenusa. Bordes biselados en los 3 lados

32 cm

9206

Maßstäbe/Zeichendreiecke

Rulers/Set Squares

Reglas/Escuadras/Escalímetros

Art.-No.

Pocket-Lineal "stano·linear"

Kunststoff glasklar, mit festem Griff, oberseitig umlaufende Facette, unterseitige Tuschennoppen.
2 Kippwinkel 45° mit Skalierung für Schraffuren und 2 Stufenskalen für horizontale Parallelen. Maßskala 14 cm, mm-Teilung mit Doppelbezeichnung.
Im Zentrum Vollkreiswinkelmesser mit 5° Teilung.

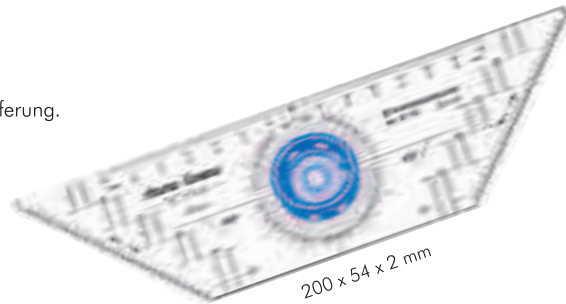

"stano·linear" pocket ruler

*made from crystal-clear plastic, with grip, facet on all edges
2 tilting corners 45° with scales for hatching, 2 scales for parallel lines.
Dimension scale 14cm, 1 mm-division.
In the centre full circle protractor with 5° division.*

Regla tecnica "stano·linear"

de plástico cristalino. Con asidero, faceta en todos los bordes, 2 bordes 45° con la escala para el rayado, 2 escalas para líneas paralelas. Escala 14 cm, la división de mm. En el centro el transportador / 5° la división.

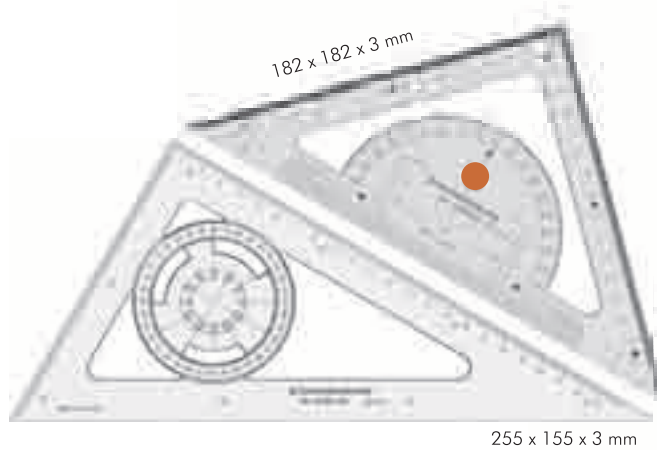

45°-Zeichendreieck

Acrylglas, 3 mm, glasklar transparent,

Set Square 45°

acrylic glas, 3 mm, transparent,

45°-Escuadra

Acrílica glas, 3 mm, transparentes,

60°-Zeichendreieck

Acrylglas, 3 mm, glasklar transparent,

Set Square 60°

acrylic glas, 3 mm, transparent,

60°-Escuadra

Acrílica glas, 3 mm, transparentes,

Verstellbarer Winkel

aus getöntem Plexiglas, stufenlos verstellbar

Adjustable Square

made from tinted plexiglas, infinitely variable adjustable

Escuadra ajustable

de plexiglas matizado de alta calidad, continua ajustable

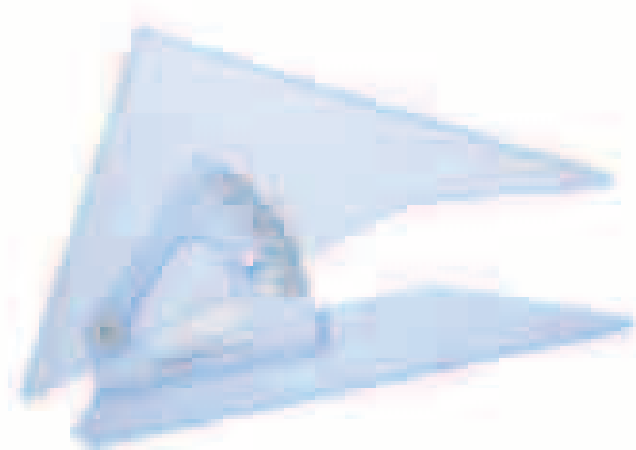

Verstellbarer Winkel

aus transparentem Plexiglas, stufenlos verstellbar mit Tuschefacette

Adjustable Square

made from transparent plexiglas, infinitely adjustable, ink facet

Escuadra ajustable

de plexiglas transparente, con borde biselado, regulación continua

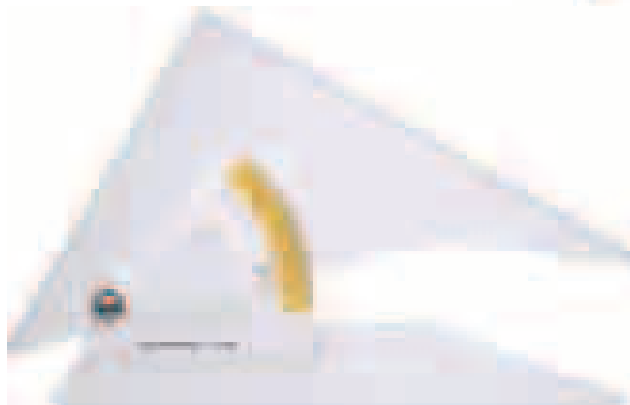

9110



9245/25



9260/25

25 cm

9325

25 cm

9425

30 cm

9430

Fächermaßstäbe
Fan-shaped reduction scale rulers
 Abanico de escalímetros

Art.-No.

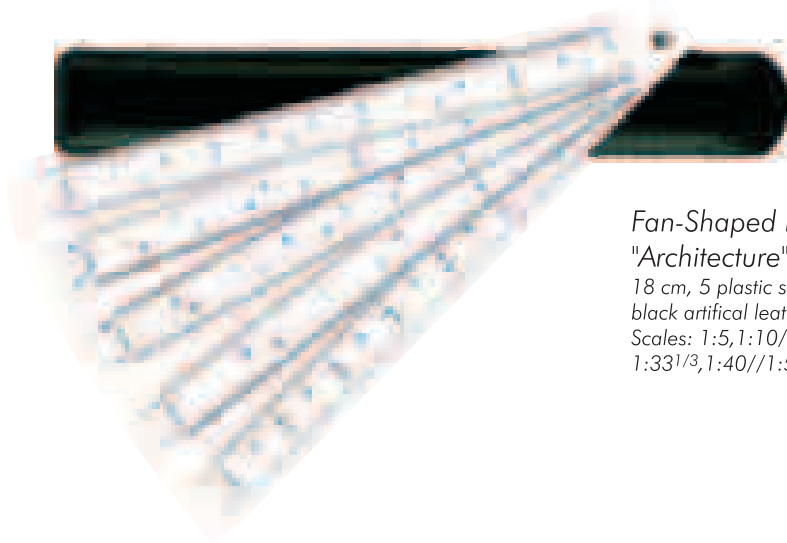

Fächermaßstab "Architekt"
 18 cm, 5 Fächer im schwarzen Kunstlederetui
 Maßstäbe: 1:5, 1:10//1:15, 1:20//1:25, 1:30//
 1:33^{1/3}, 1:40//1:50, 1:75

15 cm 905600

Fan-Shaped reduction scale ruler
 "Architecture"
 18 cm, 5 plastic strips fan rulers pushed into an
 black artificial leather case
 Scales: 1:5, 1:10//1:15, 1:20//1:25, 1:30//
 1:33^{1/3}, 1:40//1:50, 1:75

Abanico de escalímetros
 "Arquitectura"
 18 cm, en estuche de cuero artificial
 Escalas: 1:5, 1:10//1:15, 1:20//1:25, 1:30//
 1:33^{1/3}, 1:40//1:50, 1:75



Fächermaßstab "Bauwesen"
 21 cm, 6 Fächer im schwarzen Kunstlederetui
 Maßstäbe: wie Art. 905600, unterster Fächer
 für Mauerrißbreiten

20 cm 905604

Fan-Shaped reduction scale ruler
 "Building industry"
 21 cm, 6 plastic strips fan rulers pushed into an
 black artificial leather case
 Scales identical art. 905600, bottom scale to measure
 brickwork crackings

Abanico de 6 escalímetros
 "Construcción"
 21 cm, con escalímetro para medir la anchura
 de fisuras en paredes.
 Escalas como 905600

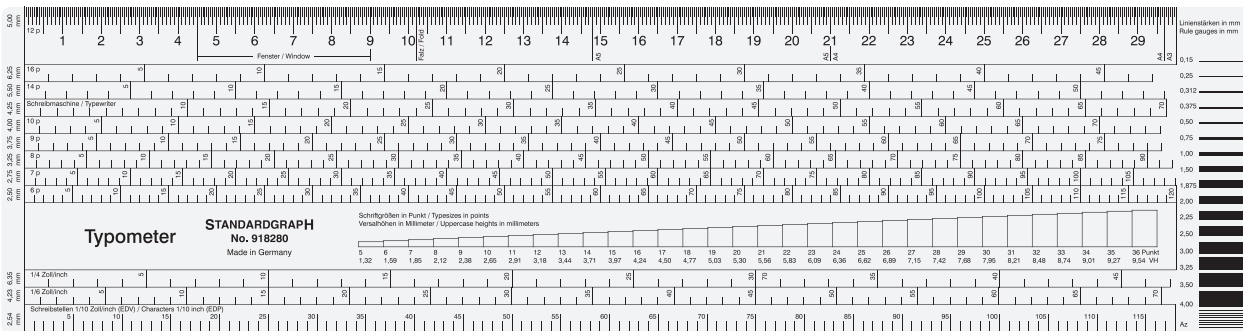

Typometer
 Schriftgrößenbestimmung: 5 bis 36 Punkt
 Versalien: 1,32 bis 9,54 mm
 Zeilenabstände: 6 bis 16 Pica/Point
 Linienstärken: 0,15 bis 4,00 mm
 Zoll-Skalen: 1/4 - 1/6 - 1/10
 Papiergrößen: DIN A5 bis DIN A3

Typometer
 type size: 5 - 36 Punkt
 capital letter: 1,32 - 9,54 mm
 line steps: 6 - 16 Pica/Point
 line width: 0,15 - 4,00 mm
 Inch-scale: 1/4 - 1/6 - 1/10
 paper size: DIN A5 - DIN A3

Typometro
 Altura de letras: 5 - 36 Punkt
 Versales: 1,32 - 9,54 mm
 para medir espacios interlineales: 6 - 16 Pica/Point
 Espesor de líneas: 0,15 - 4,00 mm
 Escalas pulgada: 1/4 - 1/6 - 1/10
 Tamaños de papel: DIN A5 - DIN A3

30 cm 918280

Zeichenplatten
 Drawing boards
 Tablero de dibujo

Art.-No.

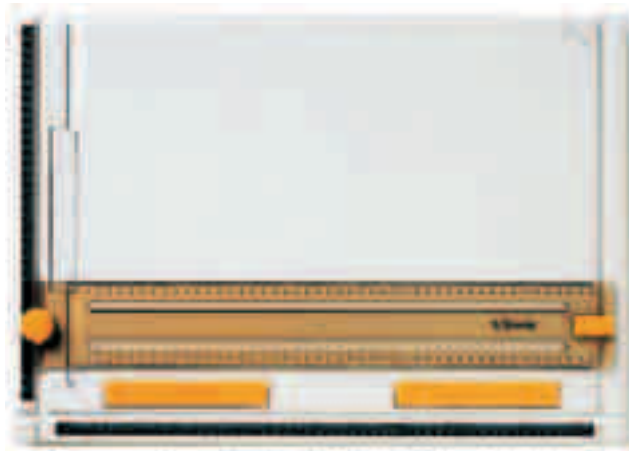

Zeichenplatte A3
 ergonomischer Stand, rutschfeste FüÙe
 3 Clips für Papierhalterung
 horizontales Lineal mit 2-facher
 Befestigung, Arbeitsfläche 34 x 48 cm

Drawing board A3
 built-in ergonomic stand, non-slip feet,
 sheet holder mechanism,
 horizontal ruler with double locking
 system, workable surface 34 x 48 cm

Tablero de dibujo A3
 incorporado en un stand ergonómico con
 anti-deslizantes pies, regla paralela con
 doble sistema de cerradura,
 superficie de trabajo 34 x 48 cm

TE-601007



TE-601/2



TE-601/3

Vertikales Lineal
 Winkellineal mit Winkelmesser 180°
 Horizontales Ersatzlineal

Vertical ruler
 Angular ruler with protractor 180°
 Horizontal ruler (spare part)

Regla vertical
 Regla angular
 Regla horizontal (recambio)

TE-601/2
 TE-601/3
 TE-601/1

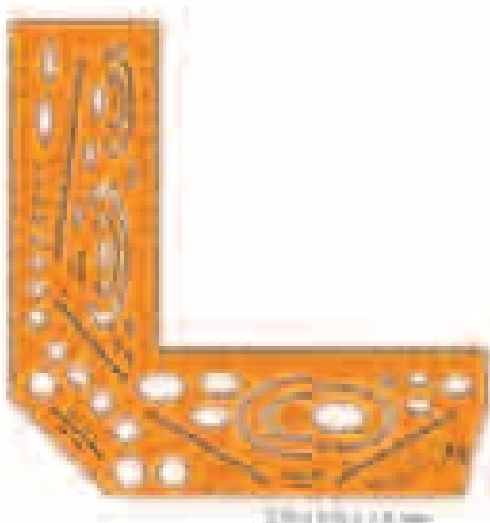

Schul-Perspektiv-Winkel für Zeichenplatten
 Winkel für Dimetrie(7°/42°), Isometrie(30°/30°)
 und Kavalierperspektive(0/45°)
 Ellipsen: 4-60 mm (Raumachse), Kreise v. ϕ 1-15 mm,
 Liniaturhilfe f. Normschrift Gr. 2,5/3,5/5 u. 7 mm

Perspective Set Square for drawing board
 angle for dimetric(7°/42°), isometric(30°/30°) and
 cavalier projection(0/45°), ellipses: 4 to 60 mm(dimetric axis)
 circels: ϕ 1-15 mm, lines for norm writing size 2,5/3,5/5
 and 7 mm

Escuadra para perspectivas para tablero de dibujo
 dimetria(7°/42°) y isometria(30°/30°) y perspectiva
 caballera(0/45°),
 Elipses: 4 a 60 mm, círculos: ϕ 1 a 15 mm
 líneas para norma que escribe tamaño 2,5/3,5/5 y 7 mm

DIN 5
 U 0,5 mm

1187

Zeichenköcher
Telescoping tubes
Tubo telescópico

Art.-No.

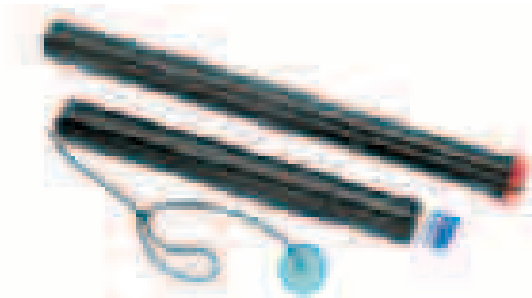

Teleskop-Köcher schwarz
farbige Kappe, $\phi 50$ mm,
40 cm ausziehbar auf 70 cm,
einstellbarer Trageriemen

Telescoping tube black
coloured cap, $\phi 50$ mm,
40 cm extendable to 70 cm,
adjustable cord

12 St. im Karton
12 pcs in a carton
12 piezas en cartón

Tubo telescópico negro
con tapa de color, $\phi 50$ mm,
extensible de 40 cm a 70 cm,
con correa ajustable

TE-79



Teleskop-Köcher schwarz
farbige Kappe, $\phi 80$ mm,
70 cm ausziehbar auf 120 cm,
einstellbarer Trageriemen

Telescoping tube black
coloured cap, $\phi 80$ mm,
70 cm extendable to 120 cm,
adjustable cord

12 St. im Karton
12 pcs in a carton
12 piezas en cartón

Tubo telescópico negro
con tapa de color, $\phi 80$ mm,
extensible de 70 cm a 120 cm,
con correa ajustable

TE-80



Schraubköcher dick
zwei Teile mit je 34 cm Länge,
 $\phi 110$ mm, farbige Kappe

Screwable tube thick
two parts, each 34 cm long,
 $\phi 110$ mm, coloured cap

9 St. im Karton
9 pcs in a carton
9 piezas en cartón

Gran Tubo negro
compuesto de 2 partes con rosca
de 34 cm, $\phi 110$ mm,
cada uno y con tapa de color

TE-AXB74

Zusätzlicher Köcher für TE-AXB74

additional tube for TE-AXB74

tubos suplementarios pare ref. TE-AXB74

TE-AXB/1



Schraubköcher dünn
zwei Teile mit je 34 cm Länge,
 $\phi 50$ mm, farbige Kappe

Screwable tube thin
two parts, each 34 cm long,
 $\phi 50$ mm, coloured cap

25 St. im Karton
25 pcs in a carton
25 piezas en cartón

Pequeno Tubo negro
compuesto de 2 partes con rosca
de 34 cm, $\phi 50$ mm,
cada uno y con tapa de color

TE-AXS74

Zusätzlicher Köcher für TE-AXS74

additional tube for TE-AXS74

tubos suplementarios pare ref. TE-AXS74

TE-AXS/1

Zeichenmappen
 Drawing wallets
 Carpetas de dibujo en plástico

Art.-No.



transparent A4

clear A4

transparente A4

transparent A3

clear A3

transparente A3

transparent A2

clear A2

transparente A2

SN-12841X
 SN-11174
 SN-10685

je Größe zu 5 Stück gepackt/size to 5 pieces packed/para tamaño a 5 piezas empaquetado



A4- Größe ohne Tragegriff/A4 size without handle/A4 tamaño sin mango

transparent A4

clear A4

transparente A4

transparent A3

clear A3

transparente A3

transparent A2

clear A2

transparente A2











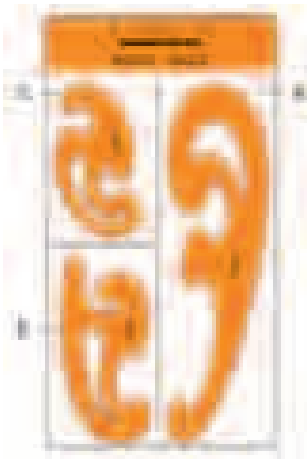

SN-13733
 SN-13734
 SN-13735

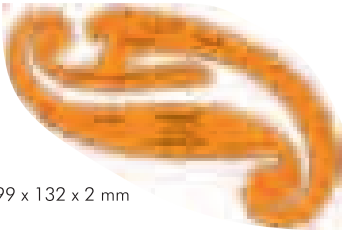
je Größe zu 5 Stück gepackt/size to 5 pieces packed/para tamaño a 5 piezas empaquetado

Allgemein Technisch Zeichnen

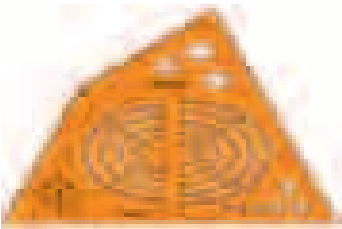
General Drawing

Dibujo técnico general

		Art.-No.			
	205 x 205 x 1,5 mm	<p>"Kurvograph" mit Parabeln, Hyperbeln, Ellipsen, Sinus- und Cosinus-Kurven.</p> <p>"Kurvograph" <i>with parabolas, hyperbolas, ellipses, sine and cosine curves.</i></p> <p>"Curvograph" con parábolas, hipérbolas, elipses, curvas senoidales y cosenoidales.</p>		1120	
	a-310 x 85 mm b-165 x 75 mm c-135 x 70 mm	<p>Burmester-Kurvenlineale 1,0 mm dick, orange transparent, kompletter Satz in Plastiktasche</p> <p><i>Burmester-French Curves</i> <i>1,0 mm thickness, transparent orange,</i> <i>set in plastic bag</i></p> <p>Curvas Burmester 1,0 mm de espesor, de color naranja transparente</p>	flexibel flexible flexibles		1121
	299 x 132 x 2 mm	<p>SICI-Kurvenlineale Mathematisch ermittelte Kurven mit Graduierung nach Krümmungsradien in mm</p> <p><i>SICI-French Curves</i> <i>Mathematical curves with graduation marks</i> <i>of the bend radii in mm</i></p> <p>Regla de curvas "SICI" Curvas determinadas matemáticamente, con graduación en mm, de acuerdo con los radios de curvatura</p>		1126F	
	375 x 130 x 1,5 mm	<p>Kreisbogenlineal Radien von 1 bis 500 mm</p> <p><i>Circular Arc Template radii from 1 to 500 mm</i></p> <p>Arcos de círculo Radios de 1 a 500 mm</p>		1127	
	240 x 135 x 2 mm	<p>Axonograph "ISOMETRIC" Seitenverhältnis: 1:1:1, Ellipsen: 4-105 mm, Winkel: 30°, 60°, 90°</p> <p><i>Axonograph "ISOMETRIC"</i> <i>side ratio: 1:1:1, ellipses: 4 to 105 mm, angles: 30°, 60°, 90°</i></p> <p>Axonógrafo "ISOMETRICO" Relación de los lados: 1:1:1, Elipses: 4 a 105 mm, Ángulos: 30°, 60°, 90°</p>		1158	
	299 x 132 x 2 mm	<p>Ellipsenschablone "ISOMETRIC" isometrische Achsen: 30-160 mm, Achsenverhältnis: 1:1,7</p> <p><i>Ellipse Template "ISOMETRIC"</i> <i>isometric axis: 30 to 160 mm, axis ratio: 1:1,7</i></p> <p>Curvas elípticas "ISOMETRICO" ejes isométricos: 30 a 160 mm, Relación de los ejes: 1:1,7</p>		1160	

Allgemein Technisch Zeichnen

General Drawing

Dibujo técnico general

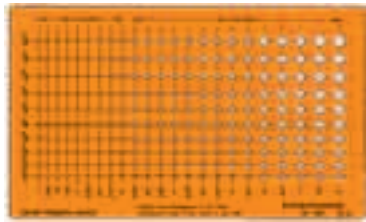

220 x 130 x 0,75 mm

Mini-Ellipsen

230 Ellipsen in den 10 gebräuchlichsten Projektionswinkeln, 15°- 60°
Lange Achse: 1- 8 mm, Abstufung 0,25 / 0,5 mm

Mini-ellipses

230 ellipses with 10 of the most commonly used projections, 15°- 60°
Major axis: 1- 8 mm, size graduation: 0.25 / 0,5 mm.

Elipses miniatura

230 Elipses en los más usuales ángulos de proyección de 15° a 60°
Eje mayor: 1 a 8 mm, graduación: 0,25 a 0,5 mm

U 0,25 mm

▼ U 0,3

U 0,35 mm

▼ U 0,5



Art.-No.

1163



150 - 280 x 180 x 0,75 mm

10teiliger Ellipsen-Schablonensatz

je 1 Schablone in den Projektionswinkeln 15°, 20°, 25°, 30°, 35°, 40°, 45°, 50°, 55°, 60°. Lange Achse: 4-60 mm, je 44 Ellipsen, Abstufung 0,5/1/2/3/5 mm, projektionsgerechter Reduktionsmaßstab

10-Piece Ellipse template set

one template each of projection angles 15°, 20°, 25°, 30°, 35°, 40°, 45°, 50°, 55°, 60°. Major axis: 4-60 mm, 44 ellipses each, size graduation: 0.5/1/2/3/5mm. projection-proportional reduction scale

Juego de 10 plantillas de elipses

1 plantilla para cada uno de los ángulos de proyección 15°, 20°, 25°, 30°, 35°, 40°, 45°, 50°, 55°, 60°. Eje mayor: 4 a 60 mm, 44 Elipses en cada plantilla, graduación: 0,5/1/2/3/5 mm, superficie antideslumbrante

U 0,5 mm



1164/
010

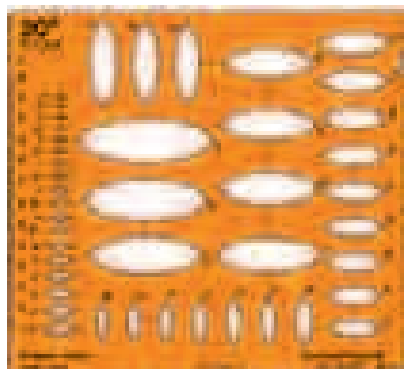

150 - 280 x 180 x 0,75 mm

Ellipsenschablonen

Lange Achse: 4-60 mm, je 44 Ellipsen,
Größenabstufung 0,5/1/2/3/5 mm,
projektionsgerechter Reduktionsmaßstab

Ellipse Templates

Major axis: 4-60 mm, 44 ellipses each,
size graduation: 0.5/1/2/3/5mm. projection-proportional
reduction scale

Plantillas de elipses

Eje mayor: 4 a 60 mm, 44 Elipses en cada plantilla,
graduación: 0,5/1/2/3/5 mm,
superficie antideslumbrante

15°

25°

30°

35°

45°

60°

U 0,5 mm



1164/15

1164/25

1164/30

1164/35

1164/45

1164/60

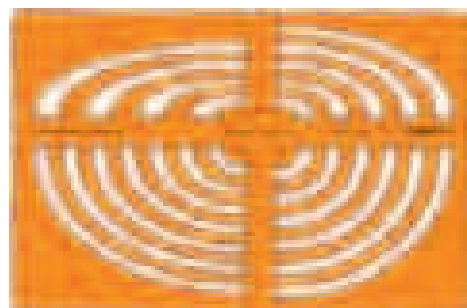

235 x 160 x 1 mm

Ellipsenzeichner

mit Viertelellipsen in verschiedenen Größen,
Achsverhältnisse: 1:1,2(55°), 1:1,5(40°), 1:2(30°), 1:3(20°)

Ellipse Drawer

with quarter ellipses in different sizes,
axis ratio: 1:1.2(55°), 1:1.5(40°), 1:2(30°), 1:3(20°)

Elipsógrafo

con cuartos de elipses en diversos tamaños. Relación
de los ejes: 1:1,2(55°), 1:1,5(40°), 1:2(30°), 1:3(20°)

U 0,5 mm



1169



295 x 150 x 1,2 mm

Ellipsenschablone "ISOMETRIC"

25 Ellipsen mit isometrischen Achsen, 4-65 mm,
Achsverhältnis: 1:1,7(35°16')

Ellipse Template "ISOMETRIC"

25 ellipses with isometric axis, 4 to 65 mm,
axis ratio: 1:1.7(35°16')

Plantilla de elipses "ISOMETRICO"

25 elipses con ejes isométricos de, 4 a 65 mm,
Relación de los ejes: 1:1,7(35°16')

DIN 5

U 0,5 mm

▼ U 0,7



1170

Allgemein Technisch Zeichnen

General Drawing

Dibujo técnico general

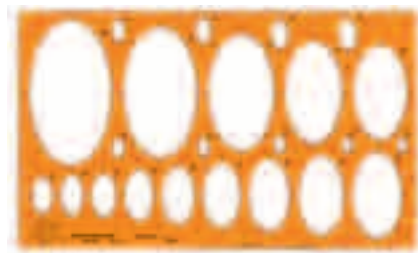

340 x 200 x 1,2 mm

Ellipsenschablone "ISOMETRIC"
23 Ellipsen mit isometrischen Achsen 10-100 mm,
Achsenverhältnis: 1:1,7 (35°16')

Ellipse Template "ISOMETRIC"
23 ellipses with isometric axis 10 to 100 mm,
axis ratio: 1:1.7 (35°16')

Plantilla de elipses "ISOMETRICO"
23 elipses con ejes isométricos de 10 a 100 mm,
Relación de los ejes: 1:1,7 (35°16')

DIN 5
U 0,5 mm
V
P

Art.-No.

1171

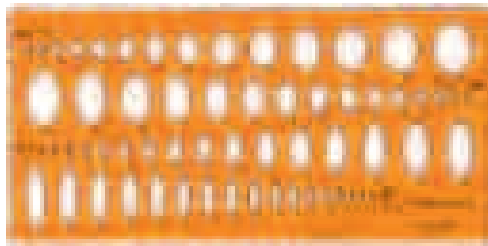

260 x 125 x 1 mm

Ellipsenschablone, 4 Projektionswinkel

Ellipse Template, 4 projection angles

Plantillas de elipses, 4 ángulos de proyección

20° (1:2,94) - 17 Ellip. 4-35 mm, 30° (1:2) - 16 Ellip. 4-32 mm,
40° (1:1,56) - 15 Ellip. 5-32 mm, 50° (1:1,29) - 14 Ellip. 5-30 mm

U 0,5 mm
V
P

1178

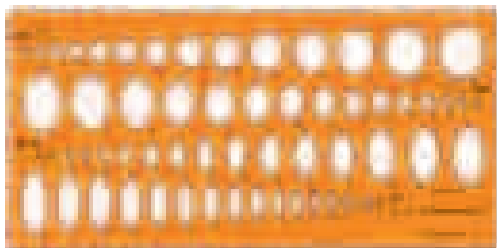

260 x 125 x 1 mm

Ellipsenschablone, 4 Projektionswinkel

Ellipse Template, 4 projection angles

Plantillas de elipses, 4 ángulos de proyección

25° (1:2,38) - 17 Ellip. 4-35 mm,
35°16'(1:1,7) Isometric - 16 Ellip. 4-32 mm,
45° (1:1,4) - 15 Ellip. 5-32 mm, 60° (1:1,14) - 14 Ellip. 5-30 mm

DIN 5
U 0,5 mm
V
P

1179



225 x 90 x 1,5 mm

Perspektivwinkel, für dimetrische Projektionen 7°/42°
Seitenverhältnis 1:1:0,5, Kavalierperspektive 0°/45°

*Perspective Set Square, for dimetric projections 7°/42°
side ratio: 1:1:0.5, cavalier projection 0°/45°*

Escuadra para perspectivas, para proyección dimétrica 7°/42°
Relación de los lados: 1:1:0,5 Perspectiva caballera 0°/45°

DIN 5
V

1183



180 x 90 x 1 mm

Axonograph I "DIMETRIC"
Seitenverh.: 1:1:0,5, Ellipsen: 3-36 mm(Raumachse),

Axonograph I "DIMETRIC"
side ratio: 1:1:0.5, ellipses: 3-36 mm(dimetric axis)

Axonógrafo I "DIMETRICO"
Relación de los ejes: 1:1:0,5, Elipses: 3 a 36 mm

Achsenverh. / axis ratios / Relación de los ejes: ~9:10 & 1:3

DIN 5
U 0,5 mm
Psi
P

1184



210 x 110 x 1 mm

Axonograph II "DIMETRIC"
Seitenverh.: 1:1:0,5, Ellipsen: 4-90 mm (Raumachse),

Axonograph II "DIMETRIC"
side ratio: 1:1:0.5, ellipses: 4-90 mm (dimetric axis)

Axonógrafo II "DIMETRICO"
Relación de los ejes: 1:1:0,5, Elipses: 4 a 90 mm

Achsenverh. / axis ratios / Relación de los ejes: ~9:10 & 1:3

DIN 5
U 0,5 mm
Psi
P

1185

Allgemein Technisch Zeichnen

General Drawing

Dibujo técnico general

Art.-No.

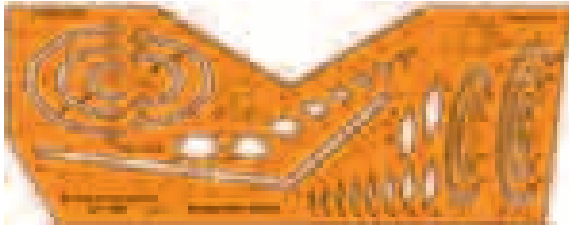

225 x 85 x 1,3 mm

Axokombi DIN 5

Isometrie und Dimetrie, Ellipsen: 3-60 mm (Raumachse)
Achsenverhältnisse: 1:1,7 (35°16'), 1:3 (20°)

Axokombi DIN 5

for isometric and dimetric, ellipses: 3 to 60 mm (dimetric axis)
axis ratios: 1:1.7 (35°16'), 1:3 (20°)

Axokombi DIN 5

Isometria y dimetria, Elipses: 3 a 60 mm,
Relación de los ejes: 1:1,7 (35°16'), 1:3 (20°)

DIN 5

 U 0,7 mm
 Ψ
 Ⓞ

1186



210 x 210 x 1,5 mm

Schul-Perspektiv-Winkel für Zeichenplatten

Winkel für Dimetrie(7°/42°), Isometrie(30°/30°)
und Kavalierperspektive(0/45°)

Ellipsen: 4-60 mm (Raumachse), Kreise v.ϕ1-15 mm,
Liniaturhilfe f. Normschrift Gr. 2,5/3,5/5 u. 7 mm

*Perspective Set Square for drawing board
angle for dimetric(7°/42°), isometric(30°/30°) and
cavalier projection(0/45°), ellipses: 4 to 60 mm(dimetric axis)
circles: ϕ1-15 mm, lines for norm writing size 2,5/3,5/5
and 7 mm*

Escuadra para perspectivas para tablero de dibujo
dimetria(7°/42°) y isometria(30°/30°) y perspectiva
caballera(0/45°),

Elipses: 4 a 60 mm, círculos: ϕ1 a 15 mm
líneas para norma que escribe tamaño 2,5/3,5/5 y 7 mm

DIN 5

 U 0,5 mm
 Ψ
 ⤴

1187

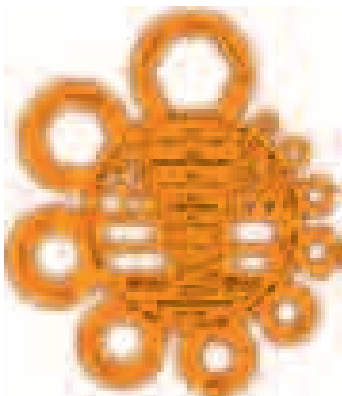

155 x 135 x 1,2 mm

Abrundungs- und Mutter-Schablone

Oberfläche blendfrei, Radien: 1-25 mm, M2-M24

Radius and Nut Template

with non-reflecting surface, radii: 1 to 25 mm, M2 to M24

Plantilla de redondeados y tuercas

Superficie antideslumbrante, Radios: 1 a 25 mm, M2 a M24

wie Art.-Nr. 1309, jedoch mit Tuschefacetten

same as Art.-No. 1309, but with ink facet

véase art. 1309,

Bordes biselado en el lado superior

DIN ISO 4014
DIN 970
DIN ISO 4032
DIN 250

 U 0,5 mm
 Ψ
 ⤴

1309

DIN ISO 4014
DIN 970
DIN ISO 4032
DIN 250

 U 0,5 mm
 Ψ
 ⤴

1309F



DIN ISO 1302
Oberflächenzeichen
Surface Symbols
Signos de mecanización de
la superficie

62 x 1,5 mm

Abrundungsschablone mit Winkelmesser 180° u. 200°

Radien: 0,5-40 mm mit Mittelpkt.Bohrung und Kreistangente

Radius Template, protractor 180° and 200°

Radii: 0.5-40 mm with centric boring and circle tangent

Plantilla de redondeados, transportadores 180° y 200°

Radios: 0,5 a 40 mm con centro perforado, tangentes

wie Art.-Nr. 1310, jedoch Oberfläche blendfrei und Tuschefacetten

same as Art.-No. 1310, but with non reflecting surface and ink facet

véase art. 1310, Superficie antideslumbrante,

Bordes biselado en el lado superior

DIN 250
DIN ISO 1302

 U 0,5/0,35 mm
 Ψ 0,3
 ⤴

1310

DIN 250
DIN ISO 1302

















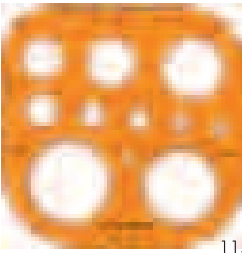







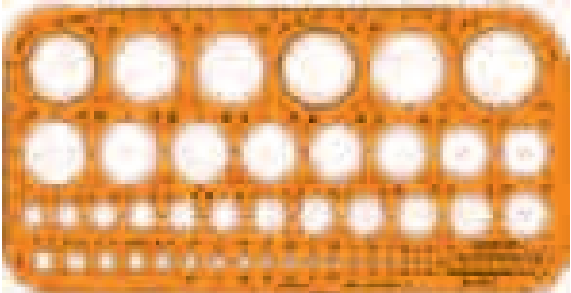



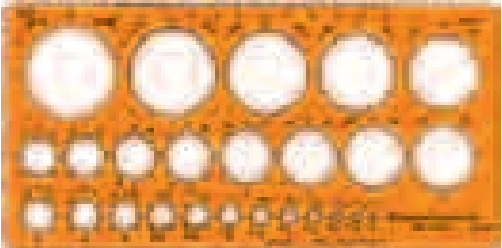

 U 0,5/0,35 mm
 Ψ 0,3
 ⤴

1310F

Allgemein Technisch Zeichnen

General Drawing

Dibujo técnico general

		Art.-No.
 <p style="text-align: right;">120 x 120 x 1,2 mm</p>	<p>Abrundungsschablone, Oberflächenzeichen, R0,5-20 mm <i>Radius Template, surface symbols, R0.5-20 mm</i> Plantilla de redondeados Signos de mecanización de la superficie, Radios: 0,5 a 20 mm</p> <p>wie Art.-Nr. 1312, jedoch mit Tuschefacetten <i>same as Art.-No. 1312, but with ink facet</i> véase art. 1312, Bordes biselado en el lado superior</p>	<p style="text-align: right;">1312</p> <p>DIN 250 (DIN 3141)  0,5 mm  </p> <p style="text-align: right;">1312F</p> <p>DIN 250 (DIN 3141)  0,5 mm  </p>
 <p style="text-align: right;">115 x 115 x 1 mm</p>	<p>Radienschablone Radien: 2,5-40 mm, %-Skala 100/1%, Winkelskala 360/1° <i>Radius Template</i> Radii: 2.5-40 mm, %-scale 100/1%, degree scale 360/1°</p> <p>Plantilla de radios Radios: 2,5 a 40 mm, Escala porcentual 100/1%, Escala de ángulos 360/1°</p>	<p style="text-align: right;">1313</p> <p>DIN 250  0,5 mm  </p>
 <p style="text-align: right;">120 x 115 x 1 mm</p>	<p>Radien-Tangenten-Schablone Radien von 0,5-50 mm <i>Radius/Tangent Template</i> radii from 0.5 to 50 mm</p> <p>Plantilla de radios-tangentes Radios de 0,5 a 50 mm</p>	<p style="text-align: right;">1314</p> <p> 0,5 mm  </p>
 <p style="text-align: right;">260 x 130 x 1,2 mm = 1315 260 x 130 x 1,5 mm = 1315F</p>	<p>Kreisschablone ϕ1-36 mm (45 Kreise), 4 Eckenradien 20-32 mm, Einweisungsmarkierungen, Feinabstufung 0,5 (ϕ1-10), Zahlen 3,5mm, Oberfläche blendfrei <i>Circles Template ϕ 1-36 mm (45 circles), flanging radii 20-32 mm, precision approach marks, fine graduation 0.5 (ϕ1-10), figures 3.5 mm, with non-reflecting surface</i></p> <p>Plantilla de círculos ϕ1 a 36 mm (45 círculos), 4 cantos redondeados 20 a 32 mm, Marcas auxiliares, Graduación fina 0,5 (ϕ1-10), Cifras 3,5 mm, Superficie antideslumbrante</p> <p>wie Art.-Nr. 1315, jedoch mit Fingerlift und Tuschefacetten <i>same as Art.-No. 1315, but with fingerlift and ink facet</i> véase art. 1315, Bordes biselado en el lado superior</p>	<p style="text-align: right;">1315</p> <p> 0,5 mm  0,35 mm  0,3 </p> <p style="text-align: right;">1315F</p> <p> 0,5 mm  0,35 mm  0,3 </p>
 <p style="text-align: right;">200 x 100 x 1,3 mm = 1316 200 x 100 x 1,5 mm = 1316F</p>	<p>Kreisschablone ϕ1-36 mm (25 Kreise) <i>Circles Template ϕ 1 to 36 mm (25 circles)</i> Plantilla de círculos ϕ1 a 36 mm (25 círculos)</p> <p>Kreisschablone ϕ1-36 mm (25 Kreise) senkrechte Achsmarkierung durch Bohrungen, in Tuschelage durch Dreieckspitzen, Oberfläche blendfrei <i>Circles Template ϕ 1 to 36 mm (25 circles)</i> vertical axial indication by borings, in ink position by triangular point, with non-reflecting surface</p> <p>Plantilla de círculos ϕ1 a 36 mm (25 círculos) Marcas vertical de los ejes por perforación y puntas triangulares, Superficie antideslumbrante</p>	<p style="text-align: right;">1316</p> <p> 0,5 mm  0,5  </p> <p style="text-align: right;">1316F</p> <p> 0,5 mm  0,5  </p>

Allgemein Technisch Zeichnen

General Drawing

Dibujo técnico general

		Art.-No.
	<p>Radien-Tangenten-Schablone Radien von 1-30 mm <i>Radius/Tangent Template radii from 1 to 30 mm</i> Plantilla de radios-tangentes Radios de 1 a 30 mm</p>	<p>1317</p> <p>U 0,5 mm </p>
	<p>Kreisbogenschablone Radien von 0,5-400 mm <i>Circular Arc Template radii from 0.5 to 400 mm</i> Plan. de arcos circulares Radios de 0,5 a 400 mm</p>	<p>1318</p> <p>U 0,5 mm </p>
<p>170 x 125 x 1 mm = 1318 170 x 120 x 1,5 mm = 1318F</p>	<p>wie Art.-Nr. 1318, jedoch mit Tuschefacette <i>same as Art.-No. 1318, but with ink facet</i> véase art. 1318, Bordes biselado en el lado superior</p>	<p>1318F</p> <p>U 0,5 mm </p>
	<p>Kreisbogenschablone Radien von 100-1000 mm <i>Circular Arc Template radii from 100 to 1000 mm</i> Plantilla de arcos circulares Radios de 100 a 1000 mm</p>	<p>1319F</p> <p>U 0,5 mm </p>
<p>170 x 105 x 1,5 mm</p>	<p>Kreisschablone "Konstrukteur 1" Kreise von $\phi 1$-13,8 mm, Feinabstufung 0,2 mm <i>Circles Template "Designer 1" circles from $\phi 1$ to 13.8 mm, fine graduation 0.2 mm</i> Plantilla de círculos "Constructor 1" Círculos con $\phi 1$ a 13,8 mm, Graduación fina 0,2 mm</p>	<p>1320</p> <p>U 0,5 mm </p>
<p>195 x 120 x 0,75 mm</p>	<p>Kreisbogenschablone Radien von 800-5000 mm im 200 mm Sprung, mit 1°-Einteilung <i>Circular Arc Template radii from 800 to 5000 mm with graduation of 200 mm, 1°-dividing</i> Plantilla de arcos circulares Radios de 800 a 5000 mm en saltos de 200 mm, con graduación de 1°</p>	<p>1323F</p> <p>U 0,5 mm </p>
<p>270 x 170 x 1,5 mm</p>		

Allgemein Technisch Zeichnen

General Drawing

Dibujo técnico general



150 x 145 x 1,5 mm

Kreishalbmesser

Radien von 0,6-125 mm, Winkelmesser 90° und 100° (Neugrad)

Circular Arc Template

radii from 0.6 to 125 mm, with 90° and 100° (new graduation) protractor

Plantilla de arcos circulares

Radios de 0,6 a 125 mm,
Transportadores 90° y 100° (grados modernos)

U 0,5 mm

→ 0,3



Art.-No.

1324



260 x 125 x 1 mm

Kreisschablone

Kreise von ϕ 38-60 mm

Circles Template

circles from ϕ 38 to 60 mm

Plantilla de círculos

Círculos con ϕ de 38 a 60 mm

U 0,5 mm

→ 0,3



1325

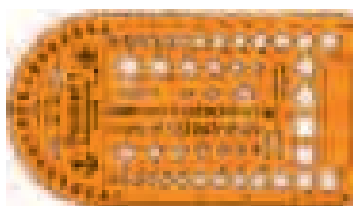

145 x 80 x 1,0 mm

Kleine Kombischablone "Pocket 1"

Geometrische Grundfiguren im Größenbereich 2-10 mm;
Pfeile, Zahlen in 3,5 und 5 mm für Feinminienstift

Multipurpose Template "Pocket 1"

with basic geometric symbols from 2-10 mm; arrows, numbers
in size 3.5 and 5 mm for fine lead pencil

Plantilla de cortes transversales "Pocket 1"

Formas geométricas básicas en tamaños de 2-10 mm; flechas,
cifras de 3,5 y 5 mm. Para portaminas de mina fina

U 0,35 mm

→ 0,5



1326



145 x 80 x 1,0 mm

Technische Pfeile "Pocket 2"

40 Pfeile in 9 verschiedenen Darstellungen. Runde und geschweifte
Klammern in 5 Größen für Feinminienstift

Template for Traffic Arrows "Pocket 2"

40 arrows in 9 different illustrations brackets and braces in 5 sizes
for fine lead pencil

Plantilla de flechas tecnicas "Pocket 2"

40 flechas en 9 diferentes modelos. Paréntesis redondos y abrazaderas
en 5 tamaños. Para portaminas de mina fina

U 0,35 mm

→ 0,5



1327

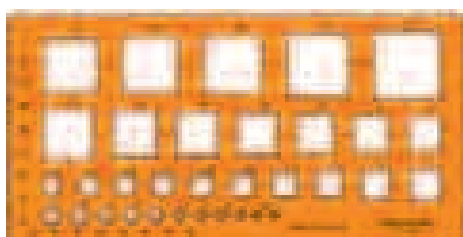

200 x 100 x 1 mm

Quadratschablone

metrische Ausführung, 2-30 mm

Squares Template

metric dimensions, 2 to 30 mm

Plantilla de cuadrados

Ejecución métrica De 2 a 30 mm

U 0,5 mm

→ 0,3



1330

Allgemein Technisch Zeichnen

General Drawing

Dibujo técnico general

Art.-No.

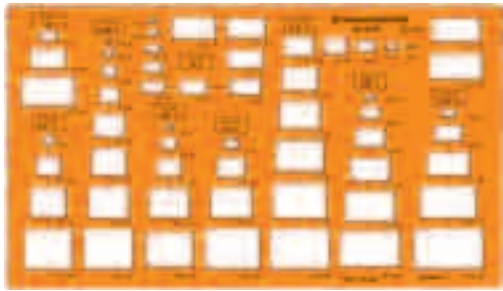

245 x 140 x 1 mm

Rechteck-Schablone
Größenbereich: 2,5 x 2 mm bis 35 x 20 mm

Rectangle Template
Dimensions from 2.5 x 2 mm to 35 x 20 mm

Plantilla de rectángulos
De 2,5 x 2 mm a 35 x 20 mm



1331

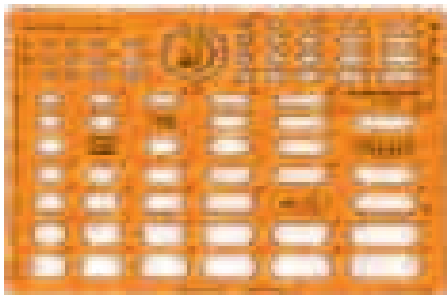

200 x 130 x 1 mm

Kontroll-Eintragung
Feldumrandungen in 75 Größen zum Hervorheben wichtiger Hinweise z.B Kontrollmaße, Prüfnummern, Toleranzen u.a. in techn. Zeichnungen

Template for control measurement frames
Rectangular frames in 75 sizes for control, serial numbers, limits of tolerance and all other information to be stressed on technical drawings.

Plantilla de casillas para medidas de control
Casillas en 75 tamaños para hacer destacar datos importantes en dibujos técnicos, p. ej. medidas de control, números de verificación, tolerancias etc.

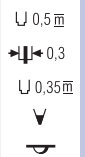

1335

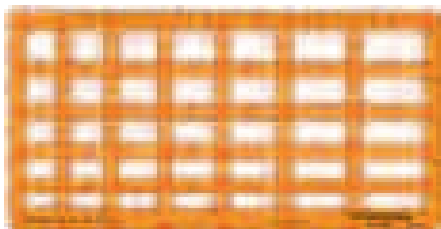

260 x 130 x 0,75 mm

Rechteck-Schablone
Größenbereich: 10 x 20 mm bis 20 x 40 mm

Rectangle Template
dimensions from 10 x 20 mm to 20 x 40 mm

Plantilla de rectángulos
Dimensiones: 10 x 20 mm a 20 x 40 mm



1336

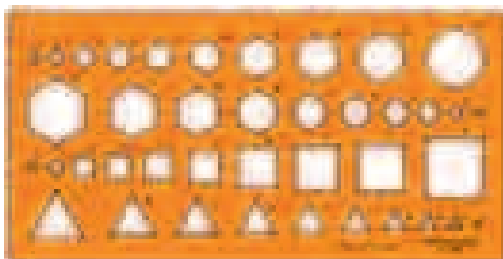

200 x 100 x 1,2 mm

Kombischablone, metrische Ausführung
Kreise, Sechsecke, Quadrate, Dreiecke von 4-24 mm

Combined Symbols Template, metric dimensions
circles, hexagons, squares, triangles, 4 to 24 mm

Plantilla de cortes transversales, Ejecución métrica
Círculos, hexágonos, cuadrados y triángulos de 4 a 24 mm



1350

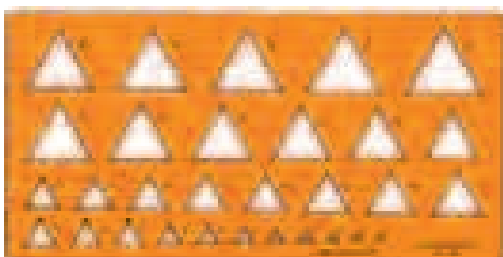

200 x 100 x 1,0 mm

Dreieckschablone, metrische Ausführung
gleichseitige Dreiecke, Seitenlänge: 3-32 mm

Triangles Template, metric dimensions
equilateral triangles, side length: 3 to 32 mm



1351

Plantilla de triángulos, Ejecución métrica
Triángulos equiláteros, Lados de 3 a 32 mm

Allgemein Technisch Zeichnen

General Drawing

Dibujo técnico general

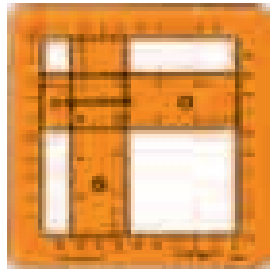

133 x 133 x 3 mm

Quadrograph

zum Zeichnen von Quadraten und Rechtecken in jedem beliebigen Seitenverhältnis. Größen: 2-68 mm, Maßstabteil.: 1:1, 1:2, 1:2,5, 1:5

Quadrograph

for drawing squares and rectangles in any combination of side ratio from 2 to 68 mm, scales: 1:1, 1:2, 1:2.5, 1:5

Quadrógrafo

Para dibujar cuadrados y rectángulos en cualquier relación de los lados. De 2 a 68 mm, Escalas: 1:1, 1:2, 1:2,5, 1:5

U 0,5 mm



Art.-No.

7010

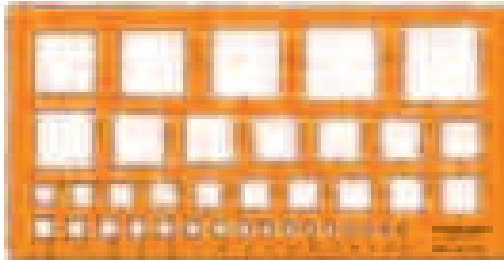

200 x 100 x 1,0 mm

Zollmaß-Quadratschablone

Größenbereich: $\frac{3}{32}$ "-1 $\frac{1}{4}$ "

Inch-Sized Square Template

Dimensions: $\frac{3}{32}$ " to 1 $\frac{1}{4}$ "

Plantilla de cuadrados en pulgadas

De $\frac{3}{32}$ " a 1 $\frac{1}{4}$ "

U 0,5 mm



1430

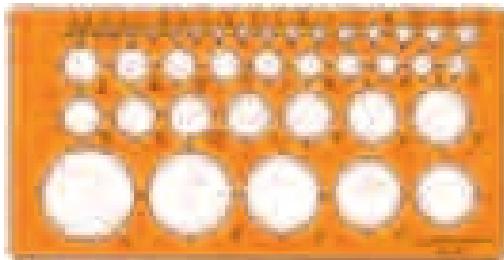

200 x 100 x 1,0 mm

Zollmaß-Kreisschablone

Größenbereich: $\phi\frac{1}{16}$ "-1 $\frac{1}{2}$ "

Inch-Sized Circles Template

dimensions from: $\phi\frac{1}{16}$ " to 1 $\frac{1}{2}$ "

Plantilla de círculos en pulgadas

De $\phi\frac{1}{16}$ " a 1 $\frac{1}{2}$ "

U 0,5 mm



1440

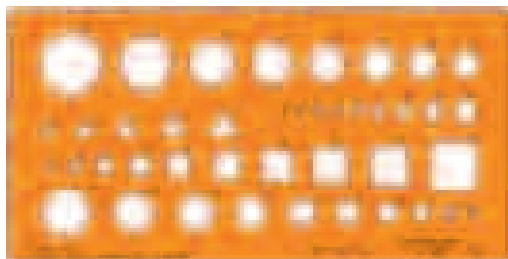

200 x 100 x 1,0 mm

Zollmaß-Kombischablone

Größenbereich: $\frac{2}{32}$ " bis $\frac{32}{32}$ "

Inch-Sized Combined Symbols Template

dimensions from: $\frac{2}{32}$ " to $\frac{32}{32}$ "

Plantilla de cortes transversales en pulgadas

De $\frac{2}{32}$ " a $\frac{32}{32}$ "

U 0,5 mm



1450

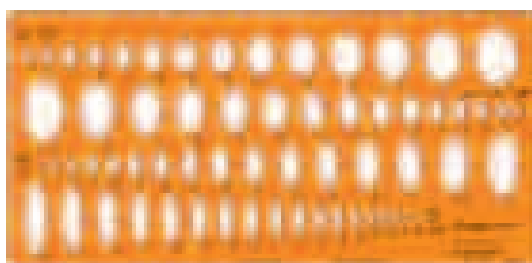

260 x 125 x 1 mm

Zollmaß-Ellipsenschablone

Größenbereich: $\frac{1}{4}$ " bis $1\frac{3}{8}$ ", 20°, 30°, 40°, 50°

Inch-Sized Ellipse Template

dimensions: $\frac{1}{4}$ " to $1\frac{3}{8}$ ", 20°, 30°, 40°, 50°

Plantilla de elipses en pulgadas

De $\frac{1}{4}$ " a $1\frac{3}{8}$ ", 20°, 30°, 40°, 50°

U 0,5 mm



1478

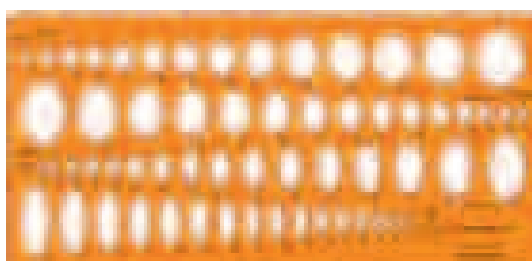

260 x 125 x 1 mm

Zollmaß-Ellipsenschablone

Größenbereich: $\frac{1}{4}$ " bis $1\frac{3}{8}$ ", 25°, 35°16', 45°, 60°

Inch-Sized Ellipse Template

dimensions: $\frac{1}{4}$ " to $1\frac{3}{8}$ ", 25°, 35°16', 45°, 60°

Plantilla de elipses en pulgadas

De $\frac{1}{4}$ " a $1\frac{3}{8}$ ", 25°, 35°16', 45°, 60°

U 0,5 mm



1479

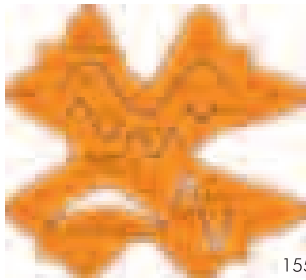

155 x 140 x 1 mm

Sinuskurven-Schablone

12 Sinuskurven mit unterschiedlicher Amplitude

Sine Curve Template

12 sine curves of different amplitudes and periods

Plantilla de curvas senoidales

12 curvas senoidales con diferentes amplitudes

U 0,7 mm

W V

P

3330



110 x 51 x 1 mm

Elektrograph Starkstrom-Installations-Schaltzeichen

Electrograph for high tension wiring diagrams

Electrógrafo

Símbolos de conexiones para instalaciones de corriente de alta intensidad

DIN 40717

U 0,35 mm

W

P

3335

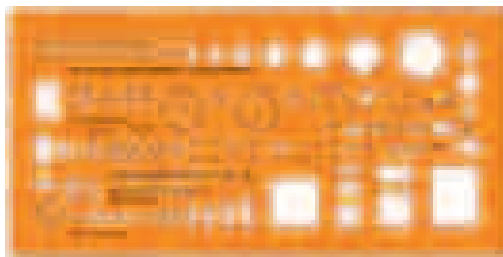

200 x 100 x 1 mm

Schaltzeichen-Schablone

"System Hoppner" Symbol-Elemente für Schaltpläne

Switchgear Symbols Template

"Hoppner System" basic symbols for circuit diagrams

Plantilla de símbolos de conexiones

"System Hoppner" Elementos de símbolos para esquemas de distribución

U 0,5 mm

W

P

U

3336

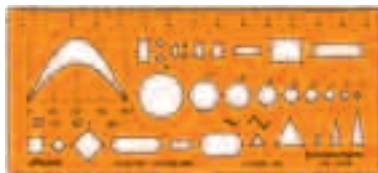

150 x 65 x 1,2 mm

Stano-Elektro-Schablone für Schule und Ausbildung

Electrical Symbols Stano-Template for school and training

Plantilla Stano de símbolos eléctricos

para el colegio y la formación profesional

U 0,5 mm

W

P

3338



260 x 100 x 1,0 mm

Elektrotechnik I

Leiter, Verbinder, Kontakte, Schalt- und Steuergeräte, elektromechanische Relais, Schutzeinrichtungen

Electrotechnics I

Circuits symbols for contact units and switching devices, installations

Plantilla de electrotecnía I

Conductores, conexiones, contactos, aparatos de distribución y mando, relés electromecánicos, dispositivos de protección

DIN 40900/
2/3
DIN 40900/
4/7
ICE 617-2-3
ICE 617-4-7

U 0,35 mm

U 0,25 mm

W 0,5

P

3341



258 x 70 x 1,1 mm

Elektrotechnik II

Leitungen, Schaltzeichen, Installationen

Electrotechnics II

Circuits symbols for contact units and switching devices, installations

Plantilla de electrotecnía II

Circuitos, símbolos de conexiones, instalaciones

DIN 40700/4
DIN 40710
DIN 40711
DIN 40717
DIN 40900

U 0,35 mm

U 0,25 mm

W 0,5

U

3342

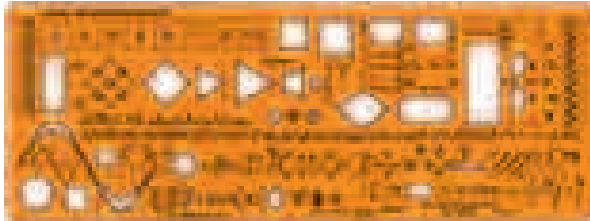

260 x 94 x 1 mm

stano-Nachrichtentechnik
 Schaltzeichen und gerade Normschrift für Ausbildung und Studium
stano-Communication Engineering
wiring symbols and upright standard lettering, for education and on-the-job training
Plantilla stano de técnica de comunicaciones
 Símbolos de conexiones y letras normalizadas para la formación profesional

DIN 40900
 Teil: 4/5/7/12
 ICE 617
 Teil: 4/5/7/12
 ISO 3098
 Teil 1/2
 DIN 6776/1
 U 0,5 mm
 H 0,5
 P

3368



260 x 94 x 1 mm

stano-Energietechnik
 Schaltzeichen und gerade Normschrift für Ausbildung und Studium
stano-Power Engineering
wiring symbols and upright standard lettering, for education and on-the-job training
Plantilla stano de técnica de la corriente fuerte
 Símbolos de conexiones y letras normalizadas para la formación profesional

DIN 40900
 Teil: 2/4/5/6/
 7/11/12
 ICE 617
 Teil: 2/4/5/6/
 7/11/12
 ISO 3098
 Teil 1/2
 DIN 6776/1
 U 0,5 mm
 H 0,5
 P

3369

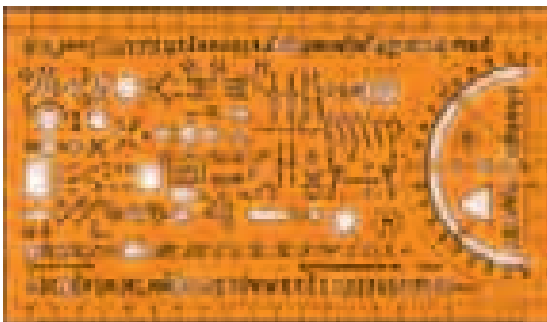

220 x 125 x 1,3 mm

Elektro-Kombi
 Schaltzeichen und gerade Normschrift
Electric all-purpose Template
wiring symbols and upright standard lettering
Plantilla combinada para electrotecnía
 Símbolos de conexiones y letras normalizadas

DIN 40700
 Teil: 1/8
 DIN 40712
 DIN 40713
 DIN 40717
 DIN 40900
 Teil 12
 ISO 3098/1
 DIN 6776/1
 Teil 1
 H 0,5
 P

3370

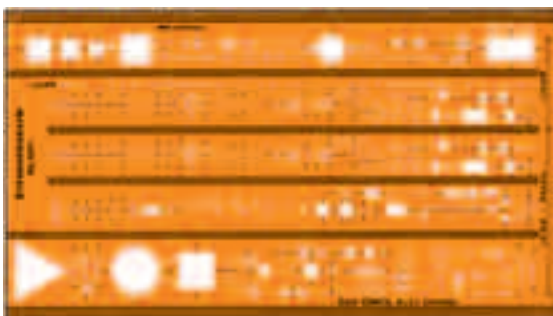

230 x 128 x 1,1 mm

Euro-Elektro
 für Ausbildung und Studium. International gültige Schaltzeichen der Elektronik, Digital- und Analogtechnik
Euro Electric Template
for education and training. Internationally valid wiring symbols for electrical engineering, electronics, digital and analog electronics.
Plantilla Euro-Elektro
 Para la formación profesional. Símbolos internacionales de conexiones para electrotécnica, electrónica, técnica, digital y analógica.

ICE 617
 DIN 40900
 U 0,35 mm
 H 0,5
 U 0,25 mm
 H 0,3
 P

3371

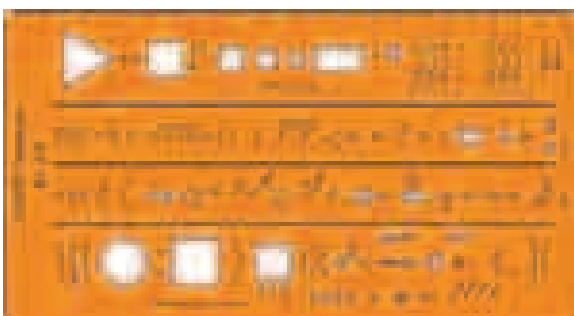

240 x 130 x 1,3 mm

Euro-Elektro
 für Ausbildung. International gültige Schaltzeichen der Elektronik, Digital- und Analogtechnik. Für Feinminienstift
Euro Electric Template
for education. Internationally valid wiring symbols for electrical engineering, electronics, digital and analog electronics. For fine lead pencil
Plantilla Euro-Elektro
 Para la formación profesional. Símbolos internacionales de conexiones para electrotécnica, electrónica, técnica, digital y analógica.
 Para portaminas de mina fina

ICE 617
 DIN 40900
 H 0,5

3372

Elektrotechnik, Elektronik
Electrotechnics, Electronics
 Electrotecnía, electrónica

Art.-No.



260 x 82 x 1,0 mm

Zeichenschablone Elektro-Installationsplan 1:100

Electrical Installations 1:100

Plantilla de instalaciones eléctricas 1:100

DIN 40900/11
 ICE 617-11

3384

U 0,25 mm

≠ 0,3



258 x 70 x 1,0 mm

Zeichenschablone Elektro-Installationsplan 1:50

Electrical Installations 1:50

Plantilla de instalaciones eléctricas 1:50

DIN 40717
 DIN 40900/11

3385

U 0,35 mm

≠ 0,5

U 0,25 mm

≠ 0,3

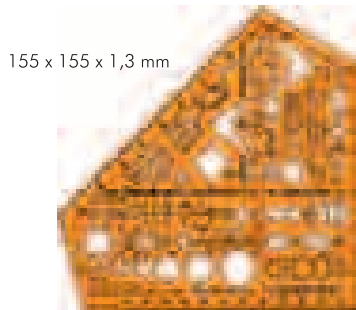

155 x 155 x 1,3 mm

Schulwinkel stano-ELEKTRO \overline{m}

für Ausbildung und Studium. Schaltzeichen für die Elektrotechnik und Elektronik.

School Set-Square stano-ELECTRO \overline{m}

for education and training. Symbols for electrotechnics and electronics.

Escuadra escolar stano-ELEKTRO \overline{m}

Para la formación profesional. Símbolos de conexiones para electrotecnía y electrónica.

DIN 40700
 Teil: 1/8/9/
 10/14
 DIN 40706
 DIN 40712
 DIN 40713
 DIN 40717
 DIN ISO 1302

8191

U 0,5/0,35 mm

≠ 0,5/0,3



Stahlbau, Maschinenbau
Construction and mechanical engineering
 Construcción metálica y de maquinaria



175 x 100 x 1 mm

Beschriftungslineal normo-type

zum Freihand-Beschriften für Schriftgrößen 2,5/3,5/5/7 und 10 mm

normo-type Lettering Rule

for free-hand lettering for type size 2.5/3.5/5/7 and 10 mm

Regla de escritura normo-type

Para la escritura de letras a pulso de 2,5/3,5/5/7 y 10 mm

U 0,25 mm

bis

U 1,0 mm



4260



150 x 56 x 1 mm

U-Stahl-Schablone Maßstab 1:10

Steel Channels Template Scale 1:10

Plantilla de acero en U Escala 1:10

DIN 1026

4301

U 0,35 mm



180 x 56 x 1 mm

Winkel-Stahl-Schablone Maßstab 1:10

Steel Angles Template Scale 1:10

Plantilla de acero angular Escala 1:10







DIN 1028
 DIN 1029

4302

U 0,35 mm

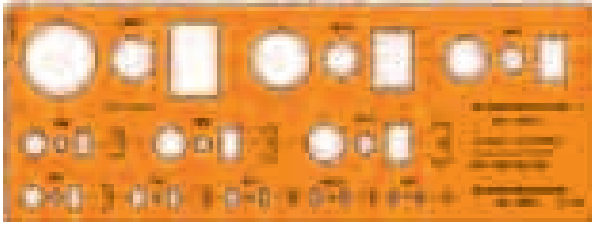
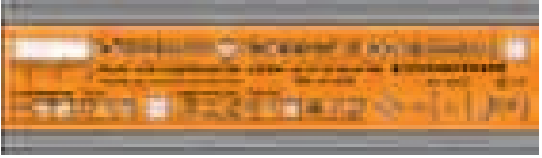

Stahlbau, Maschinenbau
 Construction and mechanical engineering
 Construcción metálica y de maquinaria

			Art.-No.
	<p>I-Stahl-Schablone Maßstab 1:10 <i>Steel Beam Template Scale 1:10</i> Plantilla de acero en I Escala 1:10</p>	<p>DIN 1025 U 0,35 mm K</p>	4303
	<p>IPE-Stahl-Schablone Maßstab 1:10 <i>IPE-Beam Template Scale 1:10</i> Plantilla de acero IPE Escala 1:10</p>	<p>DIN 1025 U 0,35 mm K</p>	4304
	<p>IPB-Stahl-Schablone 1 Maßstab 1:10 <i>IPB-Beam Template 1 Scale 1:10</i> Plantilla de acero IPB Escala 1:10</p>	<p>DIN 1025 U 0,35 mm K</p>	4305
	<p>Sechskant-Schrauben- und Muttern-Schablone M4 - M24 für Drauf- und Seitenansichten <i>Hexagon Bolts and Nuts Template M4 to M24 for plan and side view</i> Plantilla de tornillos y tuercas hexagonales M4 a M24 para vista horizontal y lateral</p>	<p>DIN 970 DIN ISO 4014 DIN ISO 4032 DIN ISO 4035 U 0,5 mm V A</p>	4321
	<p>Zeichenschablone für Zylinderkopfschrauben mit Innensechskant M2 - M20, Drauf- und Seitenansichten <i>Socket Head Cap Screw Template with hexagon socket M2 to M20, plan and side view</i> Plantilla de tornillos cilíndricos con hembra hexagonal M2 a M20, para vista horizontal y lateral</p>	<p>DIN 912 DIN 6912 DIN 966 ISO 4762 U 0,5 mm V A</p>	4324
	<p>Form- und Lagetoleranzen in Mittelschrift, vertikal 3,5 mm <i>Positional and Shape Tolerances Upright medium lettering, 3.5 mm</i> Plantilla de tolerancias de forma y posición en letras medianas verticales 3,5 mm</p>	<p>DIN ISO 1101 / 7083 DIN 17 U 0,35 mm K</p>	4330
	<p>Form- und Lagetoleranzen in Schrifttyp "B", vertikal 3,5 mm <i>Positional and Shape Tolerances Typ "B" upright lettering, 3.5 mm</i> Plantilla de tolerancias de forma y posición en letras verticales del tipo "B" 3,5 mm</p>	<p>DIN ISO 1101 / 7083 ISO 3098 DIN 6776 U 0,35 mm K</p>	4336

Stahlbau, Maschinenbau
 Construction and mechanical engineering
 Construcción metálica y de maquinaria

Art.-No.

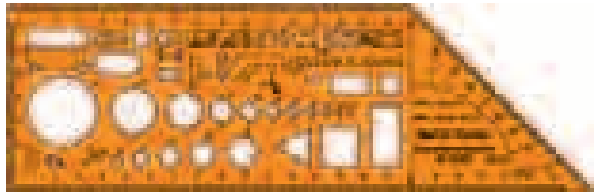

247 x 77 x 0,95 mm

Metall Kombi Für die Ausbildung. Form- und Lagetoleranzen, Schweißzeichen, Oberflächenangaben, Werkstückkanten

Metal Combi For education. Shape and positional tolerances, welding symbols, surface finish indications, workpiece edges

Plantilla combinada para metal

Para la enseñanza. Tolerancias de formas y posiciones, símbolos para soldaduras, características de superficie, bordes de piezas labradas

DIN ISO 1101
 DIN 1912
 DIN ISO 1302
 DIN 6784

4340

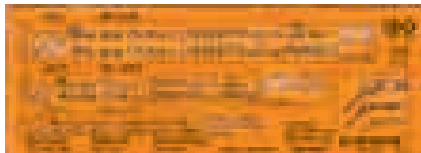

202 x 72 x 1,2 mm

Schablone für Oberflächenzeichen ISONORM
 Schrifttyp "B", vertikal, 2,5 - 3,5 - 5 mm

*Surface Finish Indication Template ISONORM
 Typ "B" upright, lettering height 2.5 - 3.5 - 5 mm*

Plantilla de símbolos de superficie ISONORM
 Letras verticales del tipo "B", 2,5 - 3,5 - 5 mm

DIN ISO 1302
 DIN 406
 DIN 6784
 ISO 3098
 DIN 6776

4351

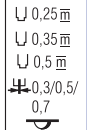

140 x 56 x 1 mm

Oberflächenzeichen \bar{m}

Surface Finish Indication Template \bar{m}

Plantilla de símbolos de superficie \bar{m}

DIN 3141
 DIN 3142

4352

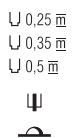

140 x 33 x 1 mm

Oberflächenzeichenschablone
 Schrifttyp "B", vertikal, 3,5 mm

*Surface Finish Indication Template
 Typ "B" upright, lettering height 3.5 mm*

Plantilla de símbolos de superficie
 Letras verticales del tipo "B" 3,5 mm

DIN ISO 1302
 DIN 6784
 ISO 3098
 DIN 6776

4357



200 x 43 x 1 mm

Oberflächenzeichenschablone
 Schrifttyp "B", vertikal, 5 mm

*Surface Finish Indication Template
 Typ "B" upright, lettering height 5 mm*

Plantilla de símbolos de superficie
 Letras verticales del tipo "B" 5 mm

DIN ISO 1302
 DIN 6784
 ISO 3098
 DIN 6776

4358

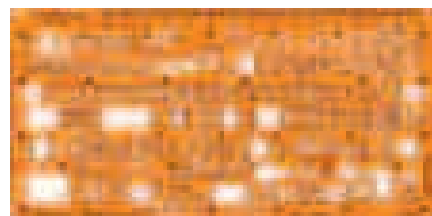

200 x 100 x 1,2 mm

Hydraulik- und Pneumatik-Schablone

Hydraulic and Pneumatic Controls Template

Plantilla de hidráulica y neumática

DIN ISO 1219

4367

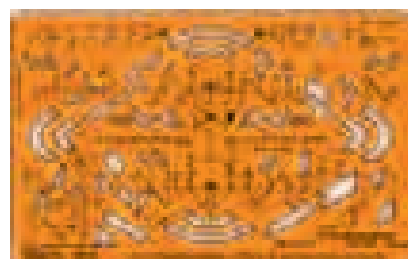

190 x 119 x 1,0 mm

ISOMETRIC-Rohrleitung

ISOMETRIC-Pipeline

Plantilla de tubería ISOMETRIC

DIN 5
 DIN 2429
 ISO 4067

4368

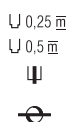

Stahlbau, Maschinenbau
 Construction and mechanical engineering
 Construcción metálica y de maquinaria

Art.-No.

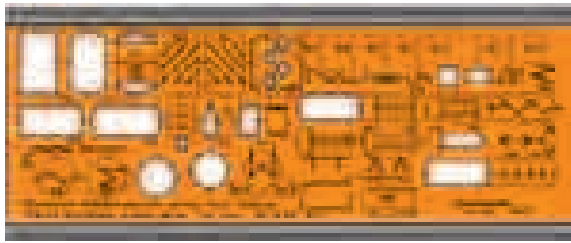

230 x 87 x 0,95 mm

I. Thermische Verfahrenstechnik
 mit Symbolen für Behälter und Rührer

Template I for Thermal Processing
 with symbols for pressure vessels, boilers and agitators

I. Plantilla de tecnología de operaciones térmicas
 con símbolos para recipientes y agitadores

DIN
28004/3

4370

U 0,5 \bar{m}

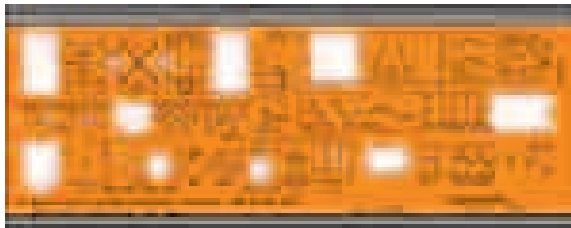

230 x 87 x 0,95 mm

II. Mechanische Verfahrenstechnik
 mit Symbolen für Brecher, Mühlen, Abscheider

Template II for Mechanical Processing
 with symbols for disintegrators, mills and cutter

II. Plantilla de tecnología de operaciones mecánicas
 con símbolos para trituradores, molinos y separadores

DIN
28004/3

4371

U 0,5 \bar{m}



230 x 87 x 0,95 mm

III. Verfahrenstechnik
 mit Symbolen für Maschinen- und Förderbänder

Template III for Processing Operations
 with symbols for machine bands and belt conveyors

III. Plantilla de tecnología de operaciones
 con símbolos para cintas transportadoras y de máquinas

DIN
28004/3

4372

U 0,5 \bar{m}

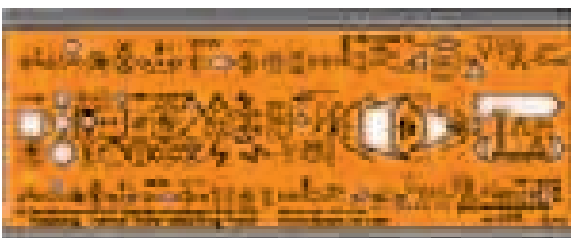

230 x 87 x 0,95 mm

IV. Verfahrenstechnik
 Wärmekraftanlagen

Template IV for Processing Technology
 Thermal power generating plants

IV. Plantilla de tecnología de operaciones mecánicas
 con símbolos para instalaciones de matriz térmica

DIN 2481
DIN 2429

4373

U 0,35 \bar{m}

U 0,25 \bar{m}

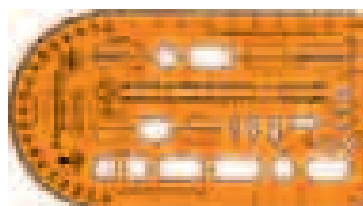

145 x 80 x 1,0 mm

für Feinminienstift
 for fine lead pencil
 para portamina
 de mina fina 0,3

Messen/Steuern/Regeln "Pocket 4"

Grafische Symbole und Kennbuchstaben für die Prozeßleittechnik

Measuring/Controlling/Regulating "Pocket 4"

Graphic symbols and recognition letters for the process control engineering

Medición/Ajuste/Reglaje "Pocket 4"

Símbolos gráficos y letras marcadoras para el control de proceso

DIN 19227/1

4375

U 0,25 \bar{m}

0,3

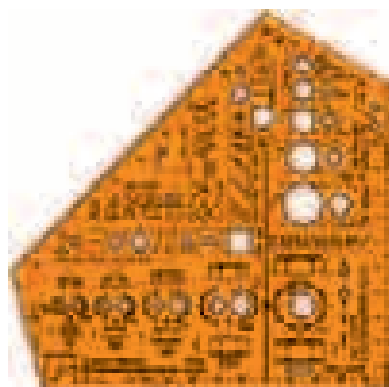

155 x 155 x 1,3 mm

Schulwinkel stano-Metall \bar{m}

für Ausbildung und Studium.

Sechskant- und Innensechskantschrauben, Schweißzeichen, Form- und Lagetoleranzen, Werkstückkanten-Bezeichnung, Oberflächenangaben.

School Set-Square stano-metal \bar{m}

for education and training.

Hexagon screws, hexagon sockets, welding joints, positional and shape tolerances, workpiece edges, surface finish indications.

Escuadra escolar stano-metal \bar{m}

Para la formación profesional.

Tornillos hexagonales, hexágonos interiores, símbolos de soldadura, tolerancias de forma y posición y símbolos de superficie

DIN ISO

4014

DIN 931

DIN 970

DIN 912

DIN ISO

1302

DIN ISO

1101

DIN 1912

DIN ISO

7083

8190

U 0,35 \bar{m}

U 0,5 \bar{m}

0,3

0,5



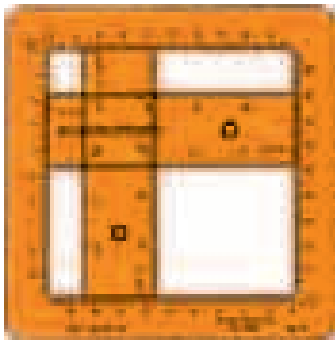

133 x 133 x 3 mm

Quadrograph

zum Zeichnen von Quadraten, Rechtecken in jedem beliebigen Seitenverhältnis.

Größen: 2 bis 68 mm, Maßstabsteilungen 1:1, 1:2, 1:2,5, 1:5

Quadrograph

for drawing squares and rectangles in any combination of side ratio from 2 to 68 mm, scales: 1:1, 1:2, 1:2.5, 1:5

Quadrógrafo

para dibujar cuadrados y rectángulos de 2 a 68 mm

Escalas: 1:1, 1:2, 1:2,5, 1:5

U 0,5 m
 Ψ ▼

7010

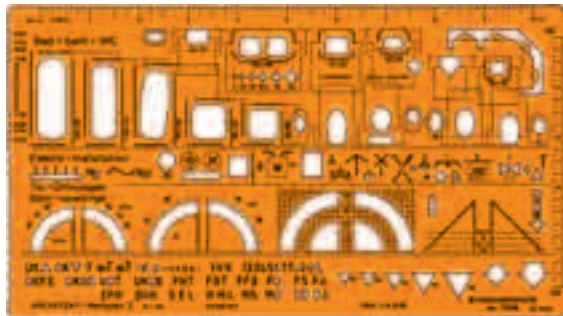

225 x 125 x 1,2 mm

Architekt-Werkplanschablone I

Maßstab 1:50, Symbole für Sanitär-Einrichtungen, Elektroinstallation, Türöffnungen, Fensterbreiten, Kurzbezeichnungen. Niveau- und Richtungssymbole.

Architect's Combination Template I

scale 1:50, with symbols for sanitary fittings, electrical installations, door openings, widths of windows, and code designations. Level and direction symbols.

Plantilla de arquitectura I

Escala 1:50, Símbolos para instalaciones sanitarias y eléctricas, huecos de puerta y ventanas, abreviaturas. Símbolos de dirección y nivel.

DIN 1356
 DIN 18022

U 0,35 m
 Ψ



7300

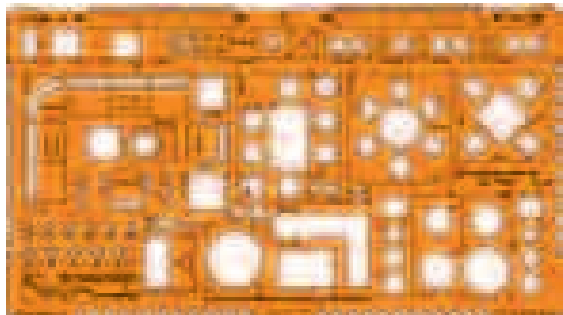

225 x 125 x 1,2 mm

Architekt-Werkplanschablone II

Maßstab 1:50, Symbole für Grundrißdarst. von Wohn-, Schlaf-, Eßraum- und Kücheneinrichtungen. Darstellung von Isolierschichten in 6 Größen.

Architect's Combination Template II

scale 1:50, with symbols for layouts of living/bed/dining rooms and kitchen furnishings. Outlines of insulating layers in 6 different sizes.

Plantilla de arquitectura II

Escala 1:50, Símbolos para dibujar planos horizontales de cuartos de estar, dormitorios y cocinas. Representación de capas aislantes en 6 diferentes tamaños.

DIN 1356
 DIN 18011
 DIN 18022

U 0,35 m
 Ψ



7301

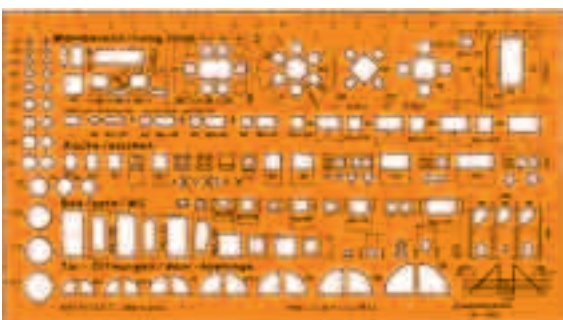

225 x 125 x 1,2 mm

Architekt-Werkplanschablone

Maßstab 1:100, Symbole für Grundrißdarst. von Wohn-, Schlaf-, Eßraum-, Küchen- und Sanitär-Einrichtungen sowie Türöffnungen im Wohnungsbau. Niveau- und Richtungssymbole

Architect's Combination Template

scale 1:50, with symbols for layouts of living/bed/dining rooms, kitchen and sanitary fittings as well as door openings in domestic construction. Level and direction symbols.

Plantilla de arquitectura

Escala 1:100, Símbolos para dibujar planos horizontales de cuartos de estar, dormitorios, cocinas, instalaciones sanitarias y huecos de puertas. Símbolos de dirección y nivel.

DIN 1356
 DIN 18011
 DIN 18022

U 0,35 m
 Ψ



7302



190 x 95 x 1 mm

Nordpfeil-Schablone

mit neun Pfeilgrößen von 25 bis 130 mm

Northern Cardinal Point - Template

with arrows in 9 sizes from 25 to 130 mm

Plantilla de flechas de posición

con 9 tamaños de flecha de 25 a 130 mm

DIN 1356
 DIN 18011
 DIN 18022

U 0,7 m
 U 1,0 m
 U 1,4 m



7310

Haustechnik
 Domestic Installation, Architecture
 Técnica doméstica

Art.-No.

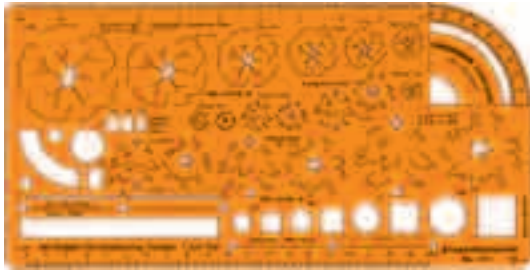

260 x 130 x 1,0 mm

Architekt - Gartenplanung
 Maßstab 1:50 und 1:100

Architect - Garden Planning
 Scales 1:50 and 1:100

Plantilla para arquitectura de jardines
 Escalas 1:50 y 1:100

U 0,5 m
 U 0,35 m
 # 0,5
 Ψ
 P

7311

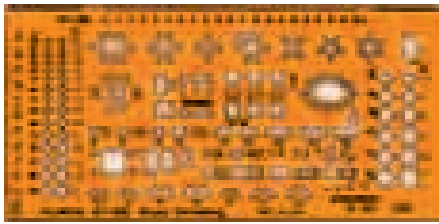

175 x 85 x 1,2 mm

Möblierungsschablone "Architekt"

Maßstab 1:200 für Einrichtungspläne im Wohn-, Schlaf-, Küchenbereich und sanitäre Anlagen.

"Architekt" Furniture Template

scale 1:200, Symbols for furnishing layouts of living rooms, bedrooms and kitchens, as well as of sanitary fittings.

Plantilla de amueblado "Arquitecto"

Escala 1:200 para planos de mobiliario en cuartos de estar, dormitorios cocinas e instalaciones sanitarias.

DIN 18011
 U 0,25 m



7341

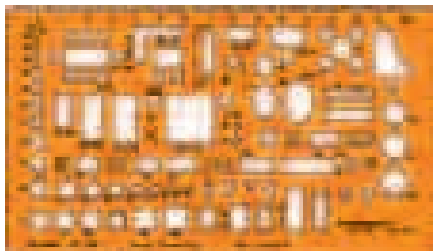

175 x 100 x 1,2 mm

Möblierungsschablone "Architekt"

Maßstab 1:100 für Einrichtungspläne im Wohn-, Schlaf-, Küchenbereich und sanitäre Anlagen.

"Architekt" Furniture Template

scale 1:100, Symbols for furnishing layouts of living rooms, bedrooms and kitchens, as well as of sanitary fittings

Plantilla de amueblado "Arquitecto"

Escala 1:100 para planos de mobiliario en cuartos de estar, dormitorios cocinas e instalaciones sanitarias.

DIN 18011
 U 0,35 m
 Ψ
 P

7342

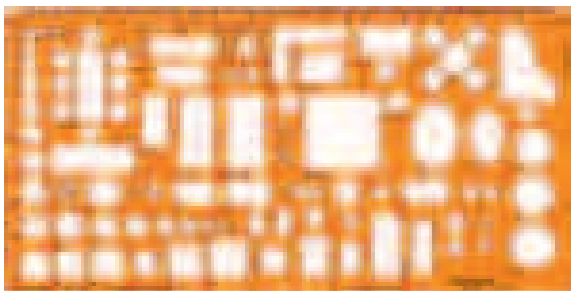

300 x 150 x 1,2 mm

Möblierungsschablone "Architekt"

Maßstab 1:50 für Einrichtungspläne im Wohn-, Schlaf-, Küchenbereich und sanitäre Anlagen.

"Architekt" Furniture Template

scale 1:50, Symbols for furnishing layouts of living rooms, bedrooms and kitchens, as well as of sanitary fittings

Plantilla de amueblado "Arquitecto"

Escala 1:50 para planos de mobiliario en cuartos de estar, dormitorios cocinas e instalaciones sanitarias.

DIN 18011
 U 0,5 m
 Ψ V
 P

7343

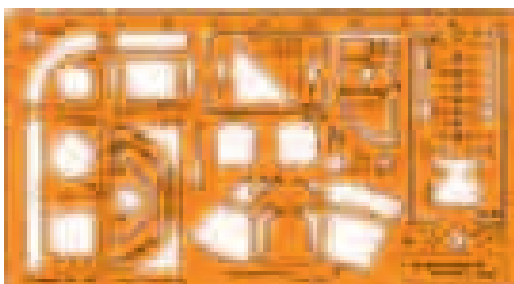

265 x 145 x 1 mm

Möblierungsschablone "Architekt"

Maßstab 1:20, Grundrißdarstellungen von Wohn- und Schlafräumen, Geschäfts-, Veranstaltungs-, Warteräume, Restaurants u.a.

"Architekt" Furniture Template

scale 1:20, Symbols for layouts of living and bedrooms, offices and showrooms, waitingrooms, restaurants etc.

Plantilla de amueblado "Arquitecto"

Escala 1:20 para planos horizontales de cuartos de estar y dormitorios, locales comerciales, salas de actos o de espera, cantinas etc.

DIN 18011
 U 0,5 m
 Ψ V
 P

7345

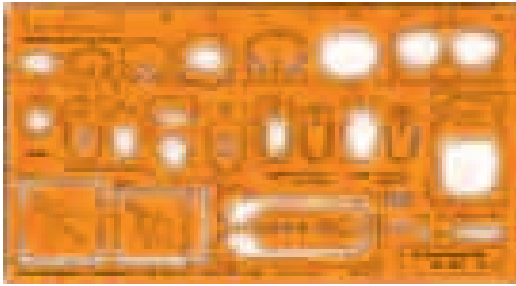

270 x 145 x 1,2 mm

Schablone für Sanitäröbjekte
 Maßstab: 1:20 in der Grundrißdarstellung

Template for sanitary fittings
scale: 1:20 outlines of sanitary objekts

Plantilla de artículos sanitarios
 Escala: 1:20 para planos horizontales

U 0,5 m

7346

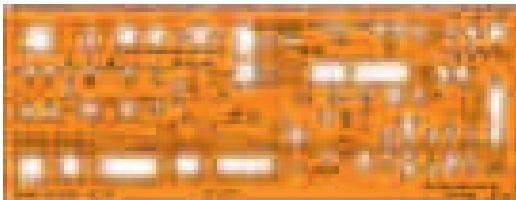

270 x 100 x 1 mm

Sanitäre Installation I
 Maßstab 1:50, Grundrißdarstellung sowie Seiten- und Vorderansicht

Sanitary Installations I
scale 1:50 outlines, side faces and front views

Plantilla de instalaciones sanitarias I
 Escala 1:50, para planos horizontales así como vistas frontales o laterales

DIN 18022

7348

U 0,35 m

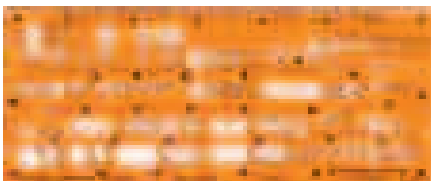

200 x 82 x 1 mm

Sanitäre Installation I
 Maßstab 1:100, Grundrißdarstellung sowie Seiten- und Vorderansicht

Sanitary Installations I
scale 1:100, outlines, side faces and front views

Plantilla de instalaciones sanitarias I
 Escala 1:100, para planos horizontales así como vistas frontales o laterales

DIN 18022

7349

U 0,25 m

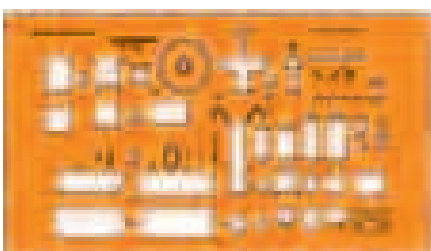

200 x 112 x 1 mm

Sanitäre Installation II
 Maßstab 1:50, Grundrißdarstellung sowie Seiten- und Vorderansicht

Sanitary Installations II
scale 1:50, outlines, side faces and front views

Plantilla de instalaciones sanitarias II
 Escala 1:50, para planos horizontales así como vistas frontales o laterales

U 0,5 m

7350





260 x 115 x 1 mm

Trinkwasser-Installation (TRWI)

zur Darstellung von Rohrleitungs- und Apparatesystemen in Trinkwasser-versorgungsanlagen in Gebäuden und Grundstücken

Installation of Water Supplies

Symbols for pipe and appliance installations of drinking water supply systems in buildings and on sites.

Plantilla de instalaciones de agua potable

para la representación de sistemas de tubería y aparatos en instalaciones para el abastecimiento de agua potable en edificios y solares.

DIN EN 806-1

7368

U 0,35 m

U 0,25 m

⊕ 0,5

⊕ 0,3

⤵

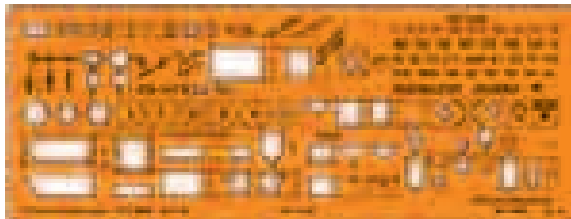

270 x 100 x 1 mm

Entwässerungsanlagen

Maßstab 1:50, für Gebäude und Grundstücke

Sewerage Systems

scale 1:50, for buildings and sites

Plantilla de obras de drenaje

Escala 1:50, para edificios y solares

DIN 1986

7369

U 0,5 m

U 0,35 m

⊕

⤵

Abbildung und Beschreibung wie 7369, jedoch Maßstab 1:100
 Illustration and description as 7369, but scale 1:100
 Ilustración y descripción como 7369, pero escala 1:100

Entwässerungsanlagen M 1:100

Sewerage Systems scale 1:100

Plantilla de obras de drenaje Escala 1:100

DIN 1986

7370

U 0,25 m

⤵



225 x 58 x 1 mm

Sanitäre Installation

Maßstab 1:100, "Wasser - Gas - Abwasser" für Leitungen in Grundrissen und Strangschemen.

Sanitary Installations Template

Scale 1:100, "water - gas - sewerage" for pipelines in plots and track plans.

Plantilla de instalaciones sanitarias

Escala 1:100, Conductos de agua, gas y aguas de desecho en planos horizontales.

DIN 2429
DIN 1988

7372

U 0,5 m

U 0,35 m

⊕

⤵-K

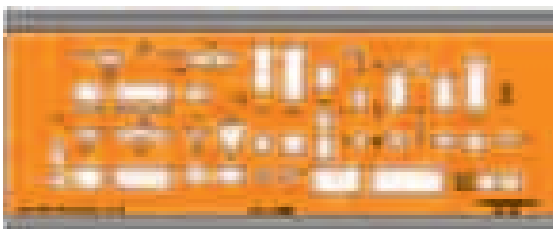

225 x 87 x 1 mm

Sanitäre Installation I

Maßstab 1:50 zur Projektierung sanitärer Anlagen

Sanitary Installations Template I

scale 1:50 for sanitary fittings planning

Plantilla de instalaciones sanitarias I

Escala 1:50 para la planificación de instalaciones sanitarias

U 0,35 m

7373

⊕

⤵-K



225 x 87 x 1 mm

Sanitäre Installation II

Maßstab 1:50 zur Projektierung sanitärer Anlagen

Sanitary Installations Template II

scale 1:50 for sanitary fittings planning

Plantilla de instalaciones sanitarias II

Escala 1:50 para la planificación de instalaciones sanitarias

U 0,35 m

7375

⊕



⤵-K

Haustechnik

Domestic Installation, Architecture

Técnica doméstica

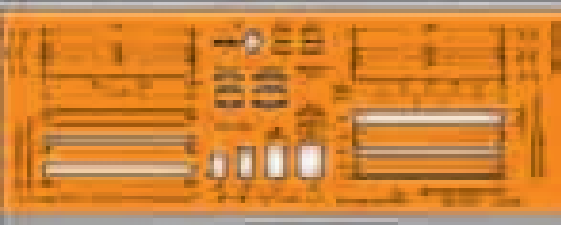
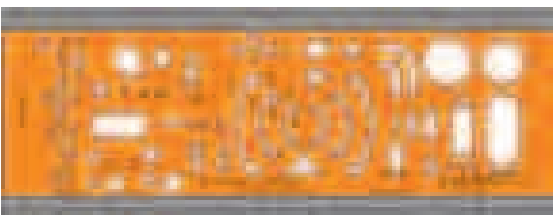
Art.-No.

<p>Abbildung und Beschreibung wie 7375, jedoch Maßstab 1:100 <i>Illustration and description as 7375, but scale 1:100</i> Ilustración y descripción como 7375, pero escala 1:100</p> <p>125 x 56 x 1 mm</p>	<p>Sanitäre Installation II Maßstab 1:100 <i>Sanitary Installations Template II scale 1:100</i> Plantilla de instalaciones sanitarias II Escala 1:100</p>	<p>U 0,35 m (U 0,25 m)</p> <p>K</p>	<p>7376</p>
 <p>225 x 85 x 1 mm</p>	<p>Heizungstechnik I Maßstab 1:50, Heizkörper, Anschlüsse <i>Central Heating Template I scale 1:50, Radiators, connections, etc.</i> Plantilla de técnica de calefacción I Escala 1:50, Radiadores y conexiones</p>	<p>DIN 4703 DIN 4807</p> <p>U 0,5 m</p> <p># 0,5</p> <p>K</p>	<p>7377</p>
<p>Abbildung und Beschreibung wie 7377, jedoch Maßstab 1:100 <i>Illustration and description as 7377, but scale 1:100</i> Ilustración y descripción como 7377, pero escala 1:100</p> <p>110 x 56 x 1 mm</p>	<p>Heizungstechnik I Maßstab 1:100 <i>Central Heating Template I scale 1:100</i> Plantilla de técnica de calefacción I Escala 1:100</p>	<p>DIN 4703 DIN 4807</p> <p>U 0,25 m</p> <p>#</p> <p>K</p>	<p>7378</p>
 <p>225 x 77 x 1 mm</p>	<p>Heizungstechnik II Maßstab 1:50, Behälter, Krümmungen, Armaturen <i>Central Heating Template II scale 1:50, tanks, pipe bends, controls, etc.</i> Plantilla de técnica de calefacción II Escala 1:50, Recipientes, curvas y grifería</p>	<p>U 0,5 m</p> <p>#</p> <p>K</p>	<p>7379</p>
<p>Abbildung und Beschreibung wie 7379, jedoch Maßstab 1:100 <i>Illustration and description as 7379, but scale 1:100</i> Ilustración y descripción como 7379, pero escala 1:100</p> <p>110 x 52 x 1 mm</p>	<p>Heizungstechnik II Maßstab 1:100 <i>Central Heating Template II Scale 1:100</i> Plantilla de técnica de calefacción II Escala 1:100</p>	<p>U 0,25 m</p> <p>K</p>	<p>7380</p>
 <p>225 x 100 x 1 mm</p>	<p>Heizungstechnik III Armaturen in drei üblichen Symbolgrößen <i>Central Heating Template III symbols for fittings in three common sizes</i> Plantilla de técnica de calefacción III Grifería en 3 tamaños usuales de símbolos</p>	<p>DIN 2429 DIN 2481</p> <p>U 0,25 m U 0,35 m U 0,5 m</p> <p># 0,3 # 0,5 # 0,7</p> <p>P</p>	<p>7381</p>
 <p>246 x 90 x 1 mm</p>	<p>Raumlufttechnik I Symbolgröße 15 mm, Planen und Zeichnen von Klimaanlage <i>Air Conditioning I Size of symbols 15 mm, Planning and drawing of airconditioning systems</i> Plantilla de técnica del aire ambiente I Dimensión de los símbolos: 15 mm, Para la planificación y representación de instalaciones de acondicionamiento de aire</p>	<p>DIN 1949 Teil 1</p> <p>U 0,5 m</p> <p># 0,7</p> <p>P</p>	<p>7384</p>

Kartenwinkelmesser und Vermessung

Cartographer, plan drawing, Surveying

Plantilla de topografía

Art.-No.

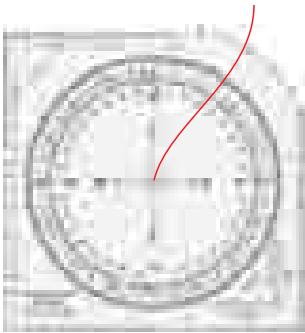

105 x 106 x 1 mm

Kartenwinkelmesser
 Teilungen: 1:50.000, 1:250.000
 Vollkreiswinkelmesser 360°/1°; Marschzahlmesser
Cartographer Plan drawing I
 scales: 1:50.000, 1:250.000;
 full circle protractor (degree divisions 360°/1°)
 Plantilla de mapas
 Graduaciones: 1:50.000, 1:250.000
 Goniómetro de círculo entero 360°/1°

7355

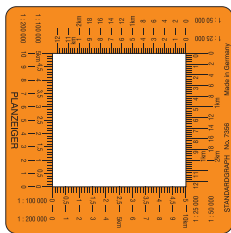

85 x 85 x 1 mm

Planzeiger
 Teilungen: 1:25.000/1:50.000, 1:100.000/1:200.000
Plan drawing
 scales: 1:25.000/1:50.000, 1:100.000/1:200.000
 Plantilla de mapas
 Graduaciones: 1:25.000/1:50.000; 1:100.000/1:200.000

7356



175 x 100 x 1 mm

Katasterschablone Planzeichen I
 Teilungen: 1:75 - 1:100 - 1:150 - 1:200 - 1:250 - 1:300 - 1:500 - 1:600
 Halbkreiswinkelmesser (Neugrad)
Cartographer Plan drawing I
 scales: 1:75 - 1:100 - 1:150 - 1:200 - 1:250 - 1:300 - 1:500 - 1:600
 semicircular protractor (degree divisions 200°/2°)
 Plantilla de mapas catastrales I
 Graduaciones: 1:75 - 1:100 - 1:150 - 1:200 - 1:250 - 1:300 - 1:500 - 1:600
 Transportador semicircular (grados centesimales)

DIN 18702

7357

U 0,5 mm

U 0,7 mm

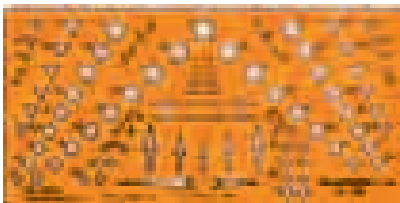

175 x 85 x 1,2 mm

Planzeichen II
 für Vermessungsrisse, Symbolgrößen: 1,5 bis 8 mm, Abstufung: 0,5 mm
Plan drawing II
 for surveyors' sketches and plans; symbols form 1.5 to 8 mm,
 graduation: 0.5 mm
 Plantilla de símbolos para planos II
 para planos topográficos, Símbolos de 1,5 a 8 mm, Graduación: 0,5 mm

U 0,5 mm

7358

U 0,25 mm



145 x 80 x 1 mm

Kataster "Pocket 5"
 Symbole für das Vermessungswesen, Neugrad-Winkelmesser 200°
Cartographer "Pocket 5"
 Symbols for surveying centesimal grade protractor 200°
 Catastro "Pocket 5"
 Símbolos para la topografía Goniómetro con grados modernos 200°

DIN 18702

7359

U 0,35 mm

0,5



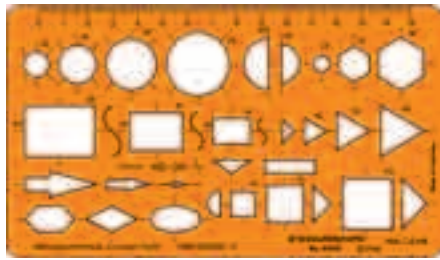

175 x 100 x 1 mm

Schablone für Netzplantechnik
mit Sinnbildern in 3 verschiedenen Größen

Critical Path Analysis Template
with symbols in 3 different sizes

Plantilla de planificación de proyectos
según método PERT
Con signos convencionales en 3 diferentes tamaños.

DIN 6900
Teil 2

8000

U 0,5 mm

± 0,5

V V

∩



210 x 60 x 2,1 mm

Schablone für Mengenlehre Figuren in mehreren Größen

Theory of Sets Template figures in various sizes

Plantilla de teoría de conjuntos Figuras en diferentes tamaños.

U 0,7 mm

8151

V

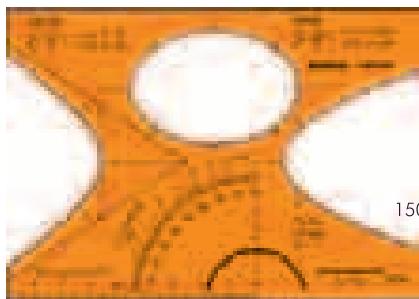

150 x 103 x 1 mm

Kegelschnittzeichner STANO-HEPAR

mit Parabel, Hyperbel und Ellipse

Conic Section Template STANO-HEPAR

with parabola, hyperbola and ellipse

Plantilla de secciones cónicas STANO-HEPAR

Con parábola, hipérbola y elipse.

∩

8176



125 x 71 x 1,5 mm

Einheitsparabel $Y=x^2$ STANO-TrigoPar

Kurven der trigonometrischen Funktionen, n-Teilung,
Sinus-Kosinus-Tangens (E-Funktion)

Parabolic Function Curve $y=x^2$ STANO-TrigoPar

standard parabola with curves for trigonometric functions, with n scales,
sine-cosine-tangent (E-function)

Parábola universal $Y=x^2$ STANO-TrigoPar

Curvas de las funciones trigonométricas, división n del seno, coseno
y tangente (función E)

U 0,7 mm

8188

V V V

∩

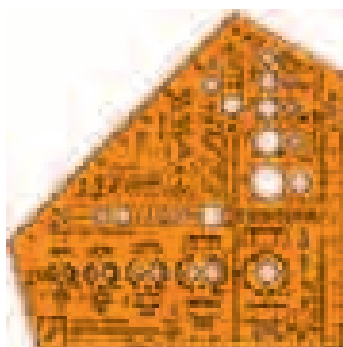

155 x 155 x 1,3 mm

Schulwinkel stano-Metall \overline{m}

für Ausbildung und Studium

Sechskant- und Innensechskantschrauben, Schweißzeichen, Form- und
Lagetoleranzen, Werkstückkanten-Bezeichnung, Oberflächenangaben.

School Set-Square stano-metal \overline{m}

for education and training

Hexagon screws, hexagon sockets, welding joints, positional and
shape tolerances, workpiece edges, surface finish indications.

Escuadra escolar stano-Metal \overline{m}

Para la formación profesional

Tornillos hexagonales, hexágono interior, símbolos de soldadura,
tolerancias de forma y posición y símbolos de superficie.

DIN ISO
4014
DIN 931
DIN 970
DIN 912
DIN ISO
1302
DIN ISO
1101
DIN 1912
DIN ISO
7083

8190

U 0,5 mm

U 0,35 mm

± 0,5 / 0,3

∩



Schulwinkel stano-ELEKTRO \overline{m}

für Ausbildung und Studium. Schaltzeichen für Elektrotechnik
und Elektronik.

School Set-Square stano-ELECTRO \overline{m}

for education and training. Symbols for electrotechnics and
electronics.

Escuadra escolar stano-ELECTRO \overline{m}

Para la formación profesional. Símbolos de conexiones para
electrotecnia y electrónica.

DIN 40700/1
/8/9/10/14
DIN 40706
DIN 40712
DIN 40713
DIN 40717
DIN ISO
1302

8191

U 0,5 mm

U 0,35 mm

± 0,5 / 0,3

∩

Ausbildung, EDV, Spezialgebiete
Education, data processing and specialized fields
 Formación, proceso de datos y especialidades

Art.-No.



200 x 125 x 1,2 mm

Chemie-Schablone "Laborgeräte"
 zur Darstellung von Versuchsaufbauten

Chemical Template "Laboratory Equipment"
 for drawings of experimental set-ups

Plantilla de química "Equipos de laboratorio"
 Para la representación de disposiciones del ensayo.

U 0,7 \bar{m}



8348



190 x 90 x 1,2 mm

Schablone für Taktische Zeichen

Natostandardisierte Truppen- und Waffensymbole für Lagepläne
 und Führungskarten. M 1:50 000, Feinfaserschreiber "S"

Tactical Troop Formations Template
 symbols for armed forces according to NATO standards, for position
 and guide maps. Scale 1:50 000, Fine liner "S"

Plantilla de signos tácticos
 Símbolos estandarizados de la OTAN para fuerzas armadas
 y armas en planos generales. Escala 1:50 000

U 0,6



8353

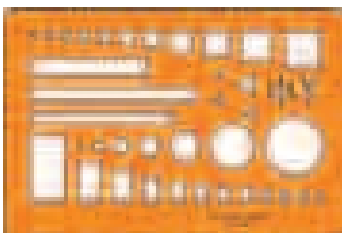

140 x 92 x 1 mm

Truppenzeichenschablone

Troop Formations Template

Plantilla de signos tácticos

U 0,5 \bar{m}



8354

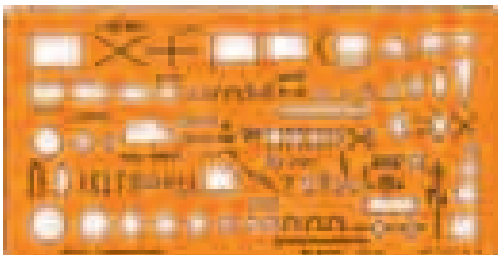

200 x 100 x 1 mm

Nato-Truppenzeichenschablone

Nato forces movements

Plantilla de signos militares OTAN

U 0,7 \bar{m}



8355



135 x 40 x 1 mm

Benzolring-Schablone

Benzene Ring Template

Plantilla de anillos de benzol

U 0,35 \bar{m}



8357

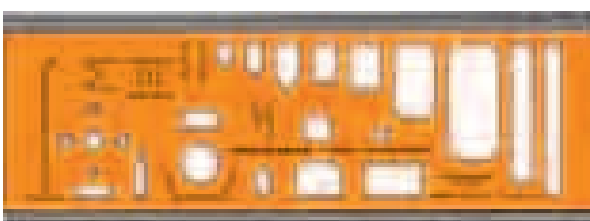

260 x 90 x 1 mm

Chemie-Schablone "Technische Apparate"

Chemistry Template "Technical Instruments"

Plantilla de química "Aparatos técnicos"

U 0,5 \bar{m}



8369

Ausbildung, EDV, Spezialgebiete
 Education, data processing and specialized fields
 Formación, proceso de datos y especialidades

Art.-No.

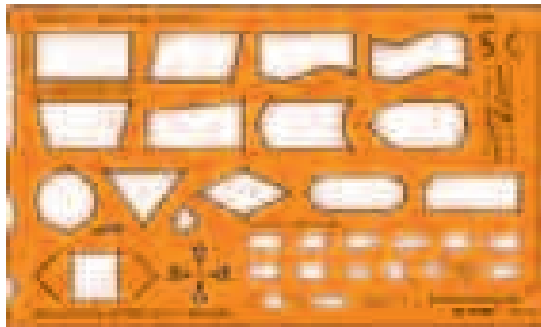

220 x 130 x 1 mm

EDV-Schablone

mit gestreckten Symbolen (Seiten 2:1), Symbolgröße 1:1 und 1/3

Template for Data-Processing

in-line coding symbols (side 2:1), symbol size 1:1 and 1/3

Plantilla de proceso de datos

con símbolos alargados (lados 2:1), Dimensión de los símbolos 1:1 y 1/3

ISO 5807

8385

U 0,5 mm

U 0,35 mm

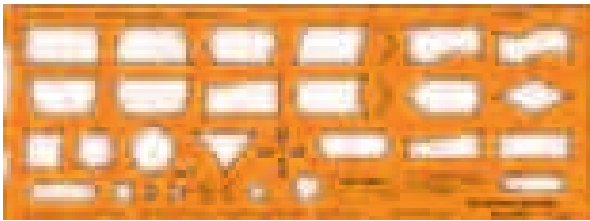

250 x 90 x 1 mm

EDV-Schablone

mit gestreckten Symbolen (Seiten 2:1), Symbolgröße 4/5

Template for Data-Processing

in-line coding symbols (side 2:1), symbol size 4/5

Plantilla de proceso de datos

con símbolos alargados (lados 2:1), Dimensión de los símbolos 4/5

ISO 5807

8388

U 0,5 mm

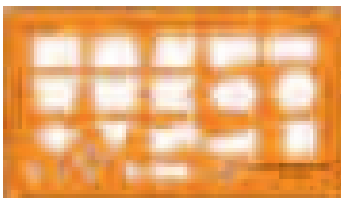

135 x 75 x 1 mm

Schablone für Datenverarbeitung

wie 8394, jedoch Sinnbilder 1/3 verkleinert

Computer Programming Template

identical with 8394, but symbols reduced by 1/3

Plantilla de proceso de datos

igual que la ref.no. 8394, pero símbolos reducidos en 1/3

DIN 66001
 Beibl. 1
 v. Dez. 83
 ISO 5807

8392

U 0,5 mm

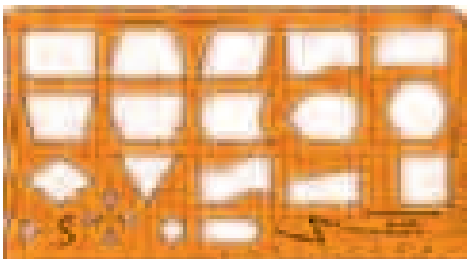

185 x 100 x 1 mm

Schablone für Datenverarbeitung

Symbole im Gitternetz, Skalen für Zeichenabstände (6, 10 Zeilen je Zoll), mm-Skala

Computer Programming Template

gridded symbols, scales for horizontal spacing (6 and 10 lines per inch), mm-graduation scale

Plantilla de proceso de datos

Símbolos sobre rejilla, escalas para el espaciado de líneas (6, 10 líneas por pulgada), escala milimetrada.

DIN 66001
 ISO 5807

8394

U 0,5 mm

U 0,7 mm

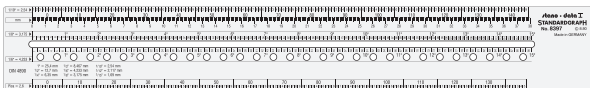

450 x 63 x 2 mm

stano-data I

EDV-Formular-Lineal aus verzugsfreiem Spezial-Kunststoff.

2 mm dick, 5 Skalen 1/6 - 1/8 - 1/10 inch, Pica- und mm-Skala

Ruler for data-processing charts, made from a special warp-proof synthetic material. Thickness: 2 mm, 5 scales 1/6 - 1/8 - 1/10 inch, Pica- and mm-scale

Regla para formularios de ordenador, de una materia plástica de 2 mm que no se deforma y con 5 escalas de 1/6 - 1/8 - 1/10 inch, Pica y milímetros.

DIN 4890

8397

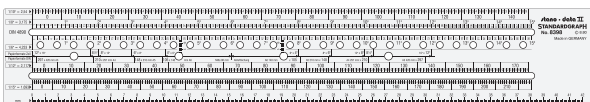

450 x 73 x 3 mm

stano-data II

EDV-Formular-Lineal aus verzugsfreiem Spezial-Kunststoff. 3 mm dick, 6 Skalen 1/6 - 1/8 - 1/10 - 1/12 - 1/15 inch und mm-Skala





Ruler for data-processing charts, made from a special warp-proof synthetic material. Thickness: 3 mm, 6 scales 1/6 - 1/8 - 1/10 - 1/12 - 1/15 inch and mm-scale

Regla para formularios de ordenador, de una materia plástica de 3 mm que no se deforma y con 6 escalas de 1/6 - 1/8 - 1/10 - 1/12 - 1/15 inch y milímetros.

DIN 4890

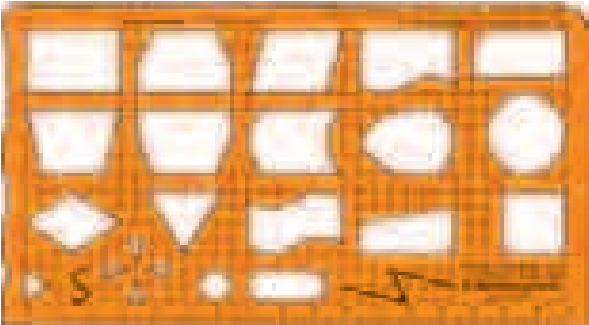
8398

Ausbildung, EDV, Spezialgebiete
 Education, data processing and specialized fields
 Formación, proceso de datos y especialidades

		Art.-No.
stano-data III EDV-Formular-Lineal / ruler for data-processing charts / Regla para formularios de ordenador		DIN 4890 8405
Abbildung und Beschreibung wie 8398, jedoch Materialstärke 1 mm Illustration and description as 8398, but template thickness 1 mm Ilustración y descripción como 8398. Pero grosor de plantilla 1 mm		
 <p>555 x 300 x 1,5 mm</p>	<p>FLIP CHART 3:1 Schab. mit 3facher Symbolgröße zur Demonstration an Wandtafeln und Flip-Charts für Vortragstätigkeit und Schulung</p> <p><i>FLIP CHART Template 3:1</i> Symbols in triple size for demonstrations on black-boards and flip charts, for lectures and training courses.</p> <p>FLIP CHART 3:1 Plantilla para conferencias y cursos, con símbolos de triple tamaño para demostraciones en pizarras y flip charts.</p>	DIN 66001 ISO 5807 8399
 <p>420 x 40 x 1,5 mm</p>	<p>Zeilenleser für Computerausdrucke mit mm- und 1/8 Zoll-Teilung</p> <p><i>Line reader for computer print-outs</i> with mm- and 1/8 inch-scale</p> <p>Lector línea por línea para impresos de ordenador con graduación en mm y 1/8"</p>	8400
 <p>260 x 95 x 1 mm</p>	<p>Schablone für Verkehrsunfallskizzen Fahrzeuge, Verkehrszeichen, Straßenleuchten, Straßenmarkierungen und Kurven. Maßstab 1:200</p> <p><i>Template for Road Accident Sketches</i> Vehicles, traffic signs, street lamps, road markings and road bends. Scale 1:200</p> <p>Plantilla de croquis para accidentes de tráfico Vehículos, señales de tráfico, alumbrado público, señalización de carreteras y curvas. Escala 1:200</p>	U 0,7 mm B V 8401
 <p>145 x 80 x 0,75 mm</p>	<p>Straßenpfeile "Pocket 3" Pfeile für die Straßenmarkierung nach STVO im Maßstab 1:100, 1:200 und 1:250</p> <p><i>Traffic Arrows "Pocket 3"</i> Arrows for road marking. Scales 1:100, 1:200 and 1:250</p> <p>Plantilla de flechas de tráfico "Pocket 3" Flechas para la señalización de carreteras según código de circulación, en escala: 1:100, 1:200 y 1:250</p>	U 0,35 mm U 0,25 mm # 0,5 # 0,3 P 8403
 <p>145 x 80 x 0,75 mm</p>	<p>Straßenverkehr "Pocket 6" Verkehrsteilnehmer, Straßenschilder, Maßstab 1:200 zur Darstellung von Verkehrssituationen</p> <p><i>Road Traffic "Pocket 6"</i> Road users, road signs, scale 1:200 for the graphic representation of traffic situations</p> <p>"Pocket 6" - Tráfico Usuarios de la vía pública y letreros de calle en escala 1:200 para la representación de situaciones de tráfico.</p>	U 0,35 mm # 0,5 P 8404

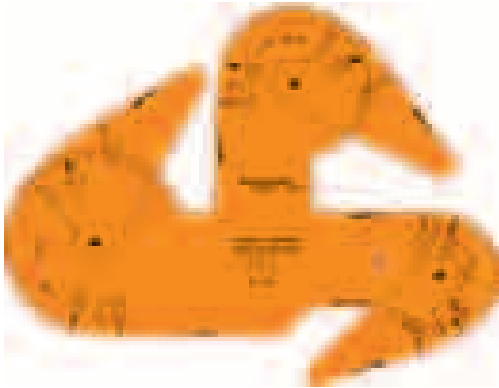

Variokurv-Schablone

Dreiteilige Straßeneinmündungsradien nach RAS-K1, für rationelles zeichnen von detaillierten Straßenbauplänen ohne Zirkel.
 Maßstab: 1:250 / Format: 265 x 174 x 1,75 mm

Variocurve Template

three-piece street junction radii according to RAS-K1 for efficient drawing of detailed road construction. drafts without compass
 Scale: 1: 250 / Size: 265 x 174 x 1.75 mm

Plantilla Variocurva

con 3 diferentes radios de desembocadura de carreteras según RAS-K1, para un dibujo regional de redes de carreteras sin compás.
 Escala: 1:250 / Tamaño: 265 x 174 x 1,75 mm

Maßstab 1:500 / Größe: 160 x 85 x 1,75 mm
 Scale 1:500 / Size: 160 x 85 x 1,75 mm
 Escala: 1:500 / Tamaño: 160 x 85 x 1,75 mm

8420

8421

Schriftschablonen
 Lettering Guides
 Plantillas de letras

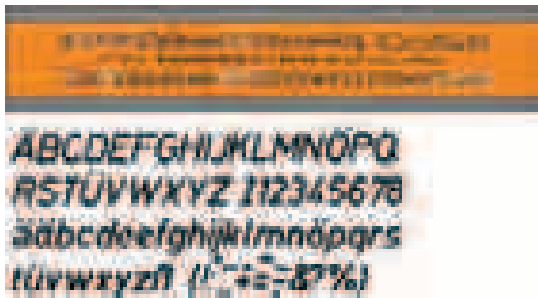

DIN 1451/4

Fette Mittelschrift kursiv

Sloping Bold Medium Lettering

Letras medianas gruesas, inclinadas

Schriftgröße Lettering Size Tamaño	Tuschezeichner Technical Pen Pluma de tinta china	Schriftgröße Lettering Size Tamaño	Tuschezeichner Technical Pen Pluma de tinta china
2 mm	□ 52	8 mm	□ 58
3 mm	□ 53	10 mm	□ 510
4 mm	□ 54	12 mm	□ 512
5 mm	□ 55	14 mm	□ 514
6 mm	□ 56	16 mm	□ 516
7 mm	□ 57		



201/...

201/2
 201/3
 201/4
 ↓
 201/16

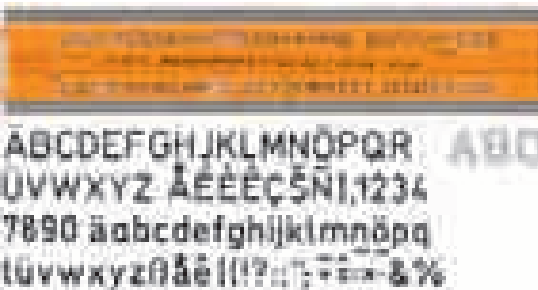

DIN 1451/4

Fette Mittelschrift gerade

Bold Upright Medium Lettering

Letras medianas gruesas, verticales

Schriftgröße Lettering Size Tamaño	Tuschezeichner Technical Pen Pluma de tinta china	Schriftgröße Lettering Size Tamaño	Tuschezeichner Technical Pen Pluma de tinta china
1,4 mm	□ 51	7 mm	□ 57
1,6 mm	□ 51	8 mm	□ 58
2 mm	□ 52	10 mm	□ 53/510
2,5 mm	□ 52	12 mm	□ 53/512
3 mm	□ 53	14 mm	□ 53/514
3,5 mm	□ 53	16 mm	□ 516
4 mm	□ 54	20 mm	□ 520
5 mm	□ 55	25 mm	□ 525
6 mm	□ 56	32 mm	□ 532



202/...

202/1,4
 202/1,6
 202/2
 202/2,5
 ↓
 202/32

Schriftschablonen
Lettering Guides
 Plantillas de letras

Art.-No.



Gerade Blockschrift
Upright Block Letters
 Letra de imprenta recta

ÄBCDEFGHIJKLMNOPQRST
 ÜVWXYZ1234567890
 ääbcdeefghijklmnöpqrstüv
 wxyz (!,;,:+&?)£\$%&

Schriftgröße Lettering Size Tamaño	Tuschezeichner Technical Pen Pluma de tinta china	Schriftgröße Lettering Size Tamaño	Tuschezeichner Technical Pen Pluma de tinta china
2 mm	□ 52	6 mm	□ 55
2,5 mm	□ 52	7 mm	□ 56
3 mm	□ 53	8 mm	□ 57
3,5 mm	□ 53	10 mm	□ 58
4 mm	□ 53	12 mm	□ 510
5 mm	□ 54		

203/...

203/2
203/2,5
203/3

203/12



Super Breitschrift "Poseidon"
"Poseidon" Lettering Style
 Letras superanchas "Poseidon"

ÄBCDEFGHIJKLMNOPQRST
 ÜVWXYZ1234567890
 ääbcdeefghijklmnöpqrstüv
 wxyz (!,;,:+&?)£\$%&

Schriftgröße Lettering Size Tamaño	Tuschezeichner Technical Pen Pluma de tinta china	Schriftgröße Lettering Size Tamaño	Tuschezeichner Technical Pen Pluma de tinta china
4 mm	□ 52	8 mm	□ 54
5 mm	□ 53	10 mm	□ 54
6 mm	□ 53	12 mm	□ 55

211/...

211/4
211/5

211/12



DIN 1451/4
 Fette Engschrift gerade
Bold Upright Condensed Style
 Letras apretadas gruesas, verticales

ÄBCDEFGHIJKLMNOPQRST
 ÜVWXYZ I 1234567890%
 ääbcdeefghijklmnöpqrst
 üvwxyzß [(!,;,:+&?)£\$%&]

Schriftgröße Lettering Size Tamaño	Tuschezeichner Technical Pen Pluma de tinta china	Schriftgröße Lettering Size Tamaño	Tuschezeichner Technical Pen Pluma de tinta china
2 mm	□ 51	8 mm	□ 58
2,5 mm	□ 52	10 mm	□ 53/510
3 mm	□ 53	12 mm	□ 53/512
3,5 mm	□ 53	14 mm	□ 53/514
4 mm	□ 54	16 mm	□ 54
5 mm	□ 55	20 mm	□ 55
6 mm	□ 56	25 mm	□ 56
7 mm	□ 57		

214/...

214/2
214/2,5
214/3

214/25



DIN 1451/4
 Fette Breitschrift gerade
Upright Bold Extended Style
 Letras anchas gruesas, verticales

ÄBCDEFGHIJKLMNOPQR
 STÜVWXYZ1234567890
 ääbcdeefghijklmnöpqrst
 üvwxyzß [(!,;,:+&?)£\$%&]

Schriftgröße Lettering Size Tamaño	Tuschezeichner Technical Pen Pluma de tinta china	Schriftgröße Lettering Size Tamaño	Tuschezeichner Technical Pen Pluma de tinta china
2 mm	□ 52	5 mm	□ 55
2,5 mm	□ 52	6 mm	□ 56
3 mm	□ 53	8 mm	□ 58
4 mm	□ 54	10 mm	□ 510

215/...

215/2
215/2,5
215/3

215/10



Architektenschrift I
Architectural Lettering I
 Letras de arquitecto I

Schriftgröße Lettering Size Tamaño	Tuschezeichner Technical Pen Pluma de tinta china	Schriftgröße Lettering Size Tamaño	Tuschezeichner Technical Pen Pluma de tinta china
4 mm	□ 52	12 mm	□ 53
5 mm	□ 52	14 mm	□ 53
6 mm	□ 53	16 mm	□ 55
7 mm	□ 53	20 mm	□ 55
8 mm	□ 53	25 mm	□ 55
10 mm	□ 53		

Art.-No.

219/...

219/4
219/5
219/6

↓
219/25

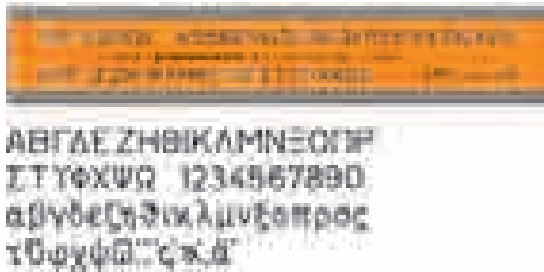

Griechische Schrift gerade
Upright Greek Letters
 Letras griegas, verticales

Schriftgröße Lettering Size Tamaño	Tuschezeichner Technical Pen Pluma de tinta china	Schriftgröße Lettering Size Tamaño	Tuschezeichner Technical Pen Pluma de tinta china
2 mm	□ 51	6 mm	□ 55
3 mm	□ 52	7 mm	□ 56
4 mm	□ 53	8 mm	□ 57
5 mm	□ 54	10 mm	□ 58

231/...

231/2
231/3
231/4

↓
231/10



Le Corbusier

Architektenschrift II, Großbuchstaben, Zahlen und Zeichen
Architectural Lettering II, capital letters, numbers and signs
 Letras de arquitecto II, mayúsculas, números y signos

Schriftgröße Lettering Size Tamaño	Tuschezeichner Technical Pen Pluma de tinta china	Schriftgröße Lettering Size Tamaño	Tuschezeichner Technical Pen Pluma de tinta china
5 mm	□ 52/ □ 0,2	14 mm	□ 55/ □ 0,5
7 mm	□ 53/ □ 0,3	20 mm	□ 56/ □ 0,6
10 mm	□ 54/ □ 0,4		

235/...G

235/5G
235/7G
235/10G
235/14G
235/20G

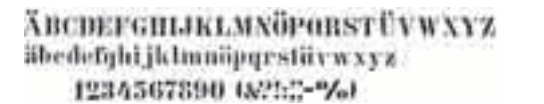

Groß- und Kleinbuchstaben, Zahlen und Zeichen
capital and small letters, numbers and signs
 mayúsculas y minúsculas letras, números y signos

Schriftgröße Lettering Size Tamaño	Tuschezeichner Technical Pen Pluma de tinta china	Schriftgröße Lettering Size Tamaño	Tuschezeichner Technical Pen Pluma de tinta china
5 mm	□ 52/ □ 0,2	10 mm	□ 53/ □ 0,4
7 mm	□ 53/ □ 0,3		

235/...N

235/5N
235/7N
235/10N



Arabisches Schrift, Farsi
Arabic Lettering, Farsi
 Letras árabes, Farsi

Schriftgröße Size Tamaño	Tuschezeichner Technical Pen Pluma de tinta china	Schriftgröße Size Tamaño	Tuschezeichner Technical Pen Pluma de tinta china
3 mm	□ 52	6 mm	□ 53
4 mm	□ 52	8 mm	□ 54
5 mm	□ 52	10 mm	□ 55

241/...

241/3
241/4

↓
241/10

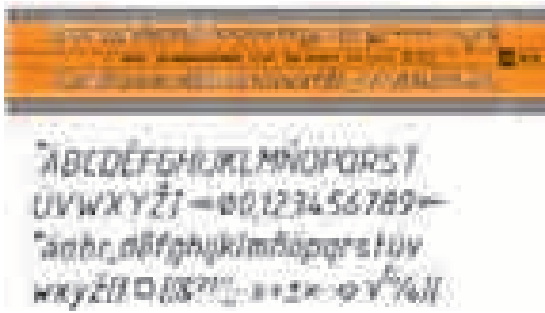

ISONORM ISO 3098/1 DIN 6776

Typ B kursiv (Mittelschrift)
Type B sloping (medium lettering)
 Tipo B inclinado

Schriftgröße Size Tamaño	Tuschezeichner Technical Pen Pluma de tinta china	Schriftgröße Size Tamaño	Tuschezeichner Technical Pen Pluma de tinta china
1,8 mm	U 0,18 mm	5 mm	U 0,5 mm
2,5 mm	U 0,25 mm	7 mm	U 0,7 mm
3,5 mm	U 0,35 mm	10 mm	U 1,0 mm



251/...

251/1,8
251/2,8

↓
251/10

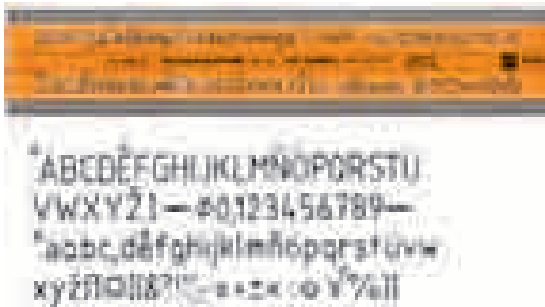

Typ B gerade (Mittelschrift)
Type B upright (medium lettering)
 Tipo B vertical

Schriftgröße Size Tamaño	Tuschezeichner Technical Pen Pluma de tinta china	Schriftgröße Size Tamaño	Tuschezeichner Technical Pen Pluma de tinta china
1,8 mm	U 0,18 mm	7 mm	U 0,7 mm
2,5 mm	U 0,25 mm	10 mm	U 1,0 mm
3,5 mm	U 0,35 mm	14 mm	U 1,4 mm
5 mm	U 0,5 mm	20 mm	U 2,0 mm



252/...

252/1,8
252/2,8

↓
252/20

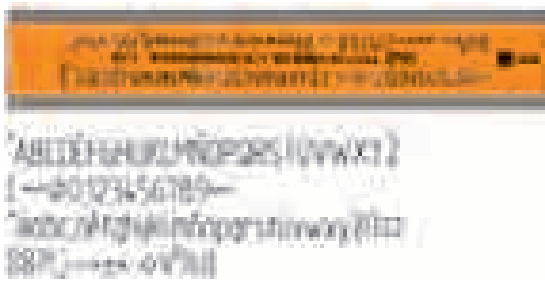

Typ A gerade (Engschrift)
Type A upright (condensed lettering)
 Tipo A vertical

Schriftgröße Size Tamaño	Tuschezeichner Technical Pen Pluma de tinta china
2,5 mm	U 0,18 mm
3,5 mm	U 0,25 mm
5 mm	U 0,35 mm
7 mm	U 0,5 mm



254/...

254/2,5
254/3,5

↓
254/7

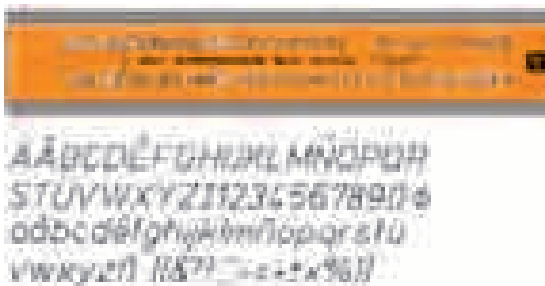

Mikronorm DIN 16
 Mittelschrift kursiv
medium lettering sloping
 Letras medianas inclinados

Schriftgröße Lettering Size Tamaño	Tuschezeichner Technical Pen Pluma de tinta china	Schriftgröße Lettering Size Tamaño	Tuschezeichner Technical Pen Pluma de tinta china
1,8 mm	U 0,18 mm	5 mm	U 0,5 mm
2,5 mm	U 0,25 mm	7 mm	U 0,7 mm
3,5 mm	U 0,35 mm		



261/...

261/1,8
261/2,5

↓
261/7

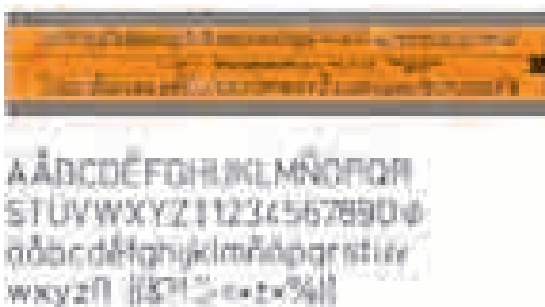

Mikronorm DIN 17
 Mittelschrift gerade
upright medium lettering
 Letras medianas verticales

Schriftgröße Lettering Size Tamaño	Tuschezeichner Technical Pen Pluma de tinta china	Schriftgröße Lettering Size Tamaño	Tuschezeichner Technical Pen Pluma de tinta china
1,8 mm	U 0,18 mm	7 mm	U 0,7 mm
2,5 mm	U 0,25 mm	10 mm	U 1,0 mm
3,5 mm	U 0,35 mm	14 mm	U 1,4 mm
5 mm	U 0,50 mm	20 mm	U 2,0 mm



262/...

262/1,8
262/2,5

↓
262/20

Schriftschablonen
Lettering Guides
 Plantillas de letras

Art.-No.



Mikronorm DIN 17
 Engschrift gerade
condensed lettering upright
 Letras apretadas verticales



264/...

A Ä B C D E F G H I J K L M N O P Q R
 S T U V W X Y Z | 1 2 3 4 5 6 7 8 9 0
 a b c d e f g h i j k l m n o p q r s t u v
 w x y z | { } [] ^ _ ` ~ + = x % & ' ()

Schriftgröße Lettering Size Tamaño	Tuschezeichner Technical Pen Pluma de tinta china	Schriftgröße Lettering Size Tamaño	Tuschezeichner Technical Pen Pluma de tinta china
2,5 mm	⌋ 0,18 mm	7 mm	⌋ 0,7 mm
3,5 mm	⌋ 0,25 mm	10 mm	⌋ 1,0 mm
5 mm	⌋ 0,35 mm		

264/2,5
 264/3,5
 264/5
 264/7
 264/10



ISONORM ISO 3098/4
 kyrillisch
Cirillic lettering
 cirílicas



282/...

А Б В Г Д Е И Ж З Й К Л М Н О П Р С Т У Ф
 Х Ц Ч Ш Щ Ъ Ы Ь Э Ю Я | 0 1 2 3 4 5 6
 а б в г д е и ж з й к л м н о п р с т у ф х ц
 ч ш щ ъ ы ь э ю я | { } [] ^ _ ` ~ + = x % & ' ()

Schriftgröße Size Tamaño	Tuschezeichner Technical Pen Pluma de tinta china	Schriftgröße Size Tamaño	Tuschezeichner Technical Pen Pluma de tinta china
2,5 mm	⌋ 0,25 mm	5 mm	⌋ 0,5 mm
3,5 mm	⌋ 0,35 mm	7 mm	⌋ 0,7 mm
		10 mm	⌋ 1,0 mm

282/2,5
 282/3,5
 ↓
 282/10

Schriftschablonen **H-Profil** für Schule und Ausbildung
Lettering Guides H-Profil for school and training
 Plantillas **deperfil H**, para colegio y formación prof.



DIN 1451/4
 Fette Mittelschrift gerade
Bold upright standard Lettering
 Letras medianas gruesas, verticales



2024/...

A Ä B C D E F G H I J K L M N O P Q
 R S T U V W X Y Z | 1 2 3 4 5 6 7 8 9 0
 a b c d e f g h i j k l m n o p q r s t
 u v w x y z | { } [] ^ _ ` ~ + = x % & ' ()

Schriftgröße Size Tamaño	Tuschezeichner Technical Pen Pluma de tinta china	Schriftgröße Size Tamaño	Tuschezeichner Technical Pen Pluma de tinta china
2 mm	⌋ 52	6 mm	⌋ 56
2,5 mm	⌋ 52	7 mm	⌋ 57
3 mm	⌋ 53	8 mm	⌋ 58
3,5 mm	⌋ 53	10 mm	⌋ 510
4 mm	⌋ 54	12 mm	⌋ 512
5 mm	⌋ 55		

2024/2
 2024/2,5
 ↓
 2024/12



ISONORM ISO 3098/1 DIN 6776
 Typ B gerade (Mittelschrift)
Type B upright (medium lettering)
 Tipo B verticales Altura del tipo



2524/...

A B C D E F G H I J K L M N O P Q R S T U
 V W X Y Z | 0 1 2 3 4 5 6 7 8 9
 a b c d e f g h i j k l m n o p q r s t u v
 w x y z | { } [] ^ _ ` ~ + = x % & ' ()

Schriftgröße Size Tamaño	Tuschezeichner Technical Pen Pluma de tinta china	Schriftgröße Size Tamaño	Tuschezeichner Technical Pen Pluma de tinta china
2,5 mm	⌋ 0,25 mm	5 mm	⌋ 0,5 mm
3,5 mm	⌋ 0,35 mm	7 mm	⌋ 0,7 mm
		10 mm	⌋ 1,0 mm

2524/2,5
 2524/3,5
 ↓
 2524/10

3er Satz (3,5 - 7mm)/Set of 3 (3.5 to 7 mm)/Juego de 3 (3,5 a 7 mm)
 4er Satz (2,5 - 7mm)/Set of 4 (2.5 to 7 mm)/Juego de 4 (2,5 a 7 mm)

2524/03
 2524/04

Schriftschablonen

Lettering Guides

Plantillas de letras



ABCDEFGHIJKLMN O P Q R S T
 UVWXYZ 1 - 0 1 2 3 4 5 6 7 8 9
 abcdefghijklmnopqrstuv
 wxyz 0 1 2 3 4 5 6 7 8 9



ABCDEFGHIJKLMN O P Q R S T U
 VWXY Z 1 - 0 1 2 3 4 5 6 7 8 9
 abcdefghijklmnopqrstuv
 wxyz 0 1 2 3 4 5 6 7 8 9



ABCDEFGHIJKLMN O P Q R S T U
 VWXY Z 1 - 0 1 2 3 4 5 6 7 8 9
 abcdefghijklmnopqrstuv
 wxyz 0 1 2 3 4 5 6 7 8 9

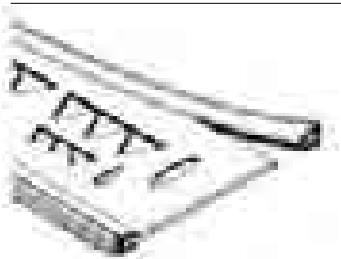

ISONORM ISO 3098/1 DIN 6776

stano•type - mit Abstandsklammern/
 with space indicator/con marcas distanciadores

Typ B kursiv (Mittelschrift)
 Type B sloping (medium lettering)
 Tipo B cursiva (letras medianas)

Schriftgröße Size Tamaño	Tuschezeichner Technica. Pen Pluma de tinta china	Schriftgröße Size Tamaño	Tuschezeichner Technica. Pen Pluma de tinta china
2,5 mm	U 0,25 mm	5 mm	U 0,5 mm
3,5 mm	U 0,35 mm	7 mm	U 0,7 mm

4er Satz (2,5 - 7 mm)/Set of 4 (2.5 to 7 mm)/Juego de 4 (2,5 a 7 mm)

Typ B gerade (Mittelschrift)
 Type B upright (medium lettering)
 Tipo B vertical (letras medianas)

Schriftgröße Size Tamaño	Tuschezeichner Technica. Pen Pluma de tinta china	Schriftgröße Size Tamaño	Tuschezeichner Technica. Pen Pluma de tinta china
2,5 mm	U 0,25 mm	5 mm	U 0,5 mm
3,5 mm	U 0,35 mm	7 mm	U 0,7 mm

4er Satz (2,5 - 7 mm)/Set of 4 (2.5 to 7 mm)/Juego de 4 (2,5 a 7 mm)

stano•100 ISONORM ISO 3098/1 DIN 6776

Typ B gerade (Mittelschrift)/Type B upright
 (medium lettering)/Tipo B vertical (letras medianas)

Schriftgröße Size Tamaño	Tuschezeichner Technica. Pen Pluma de tinta china	Schriftgröße Size Tamaño	Tuschezeichner Technica. Pen Pluma de tinta china
2,5 mm	U 0,25 mm	5 mm	U 0,5 mm
3,5 mm	U 0,35 mm	7 mm	U 0,7 mm
		10 mm	U 1,0 mm

4er Satz (2,5 - 7 mm)/Set of 4 (2.5 to 7 mm)/Juego de 4 (2,5 a 7 mm)

ISONORM-Schriftschablone für Feinminenstift U 0,5
 Typ B gerade (Mittelschrift) mit 2 Schriftgrößen 3,5 und 5 mm

ISONORM-Lettering Guides for fine pencil U 0.5
 Typ B upright (medium lettering) two letter sizes 3.5 and 5 mm

ISONORM-para portaminas de mina fina U 0,5
 Tipo B verticales (letras medianas)
 con 2 alturas de letra 3,5 y 5 mm

DuoScript•FINELINER ISONORM-Schriftschablone
 Kombi-Schablone für **Feinfaserstifte** U und **Feinminenstifte** U
 mit 2 Schriftgrößen 3,5 und 5 mm. Typ B gerade

DuoScript•FINELINER ISONORM-Lettering Guides
 Combination lettering guide for **fine felt** U and **fine lead pencil** U
 two lettering sizes 3.5 and 5 mm. Typ B upright

DuoScript•FINELINER para colegio y formación profesional
 Plantilla de letras combinada para rotuladores **finos de fibra** U
 y **portaminas de mina fina** U con 2 alturas de letra 3,5 y 5 mm

Kunststoffleisten
 auf Zeichenschablonen aufsetzbar, Stablänge: 0,5 m, 10er-Pack.

Plastic Edge Strips
 to be mounted on templates, length: 0.5 m, 10 pcs.-pack

Listones de plástico
 para montar en plantillas, Largo: 0,5 m, Embalados por 10

Art.-No.

2512/...

2512/2,5
2512/3,5

2512/7

2512/04

2522/...

2522/2,5
2522/3,5

2522/7

2522/04

2525/..

2525/2,5
2525/3,5

2525/10

2525/04

U 2521

2523

3,5 mm
U 0,3/0,5
U 0,1/0,3

5 mm
U 0,7/0,9
U 0,5/0,7

2300

Die Funktionsmerkmale und Informationen auf STANDARDGRAPH-Schablonen

Technical information and indications printed on STANDARDGRAPH-templates

Marcas de utilización e informaciones en las plantillas STANDARDGRAPH

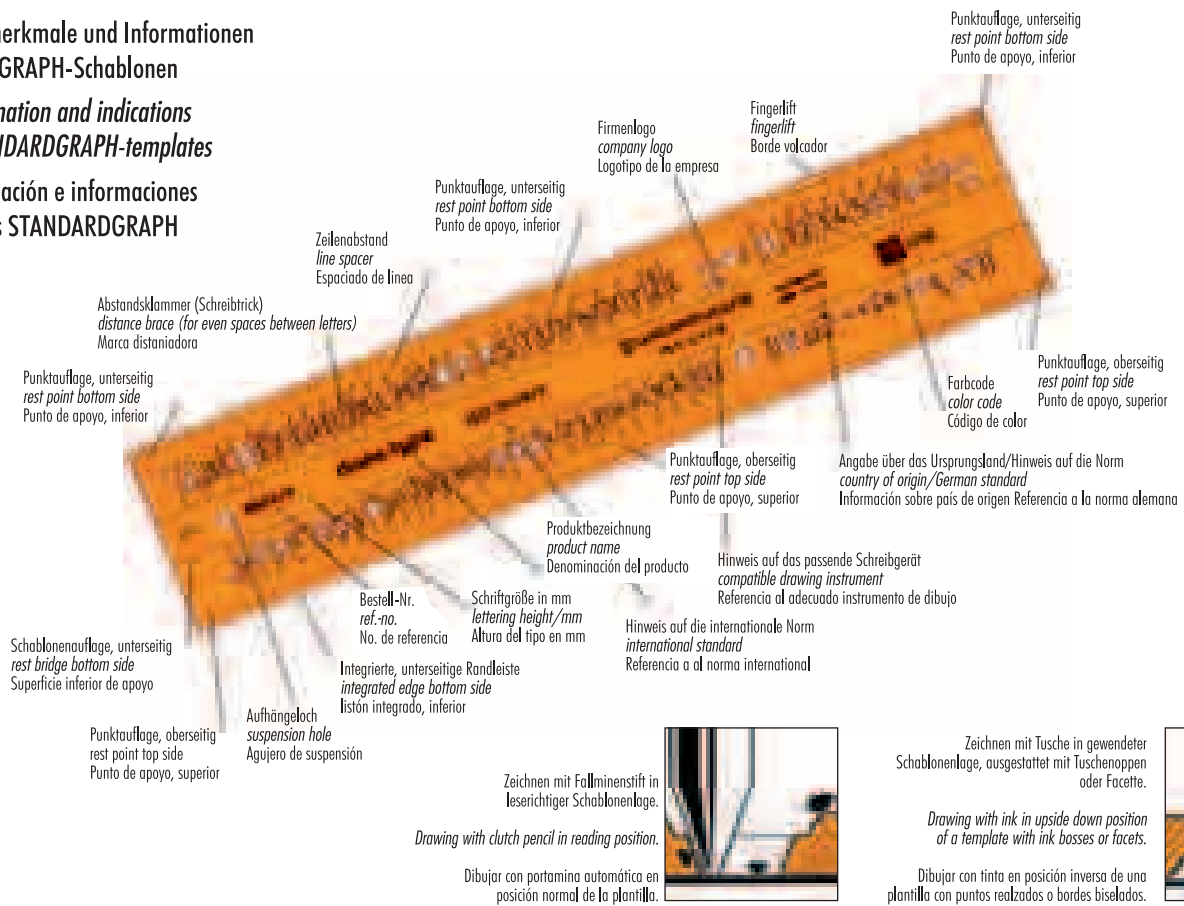

Kurzzeichen Papierabstand Paper spacer Símbolo para la distancia al papel	Schreibgeräteauswahl Choice of drawing instrum. Elección del instrumento de escritura					Erläuterungen Additional Information Aclaraciones
Festverankerte Metall-Leiste Standardausführung Schriftschablone <i>Firmly braced metal strips</i> regular version lettering guides Listones fijos de metal Ejecución standard para plantillas de letras						⊥ = Tuschezeichner mit Tuschestufe, ⊥ = Tuschezeichner Planröhren/Trichterfeder, in seitenrichtiger Schablonenlage. <i>Technical pens, ⊥ - pens with ink step, ⊥ - funnel pens, in reading position.</i> ⊥ - Estilógrafo técnico. ⊥ - Pluma de embudo en posición normal de la plantilla.
Abziehbare Kunststoff-Leiste Schrift- und Zeichenschablonen, generell bei Schriften ab 10 mm <i>Detachable plastic strips</i> templates and lettering guides, all lettering heights larger than 10 mm Listones desprendibles de plástico Para plantillas de letras y símbolos, generalmente para letras de más de 10 mm						Tuschezeichner, Trichterfeder bei aufgesteckten Leisten. Füllminenstift, Feinminenstift, Fineliner bei abgezogenen Leisten, in seitenrichtiger Schablonenlage. <i>Technical pens, funnel pens when strips are mounted; clutch pens, fine lead pencils, fineliners with strips detached, in reading position.</i> Estilógrafo técnico o pluma de embudo con listones puestos. Portamina automática, portamina de mina fina o fineliner, en posición normal de la plantilla.
Integrierte Randleiste und Schablonenprofile (z.B. preiswerte Schriftschablonen) <i>Integrated edge profiles and H-profiles</i> (e.g. low-priced lettering guides) Bordes integrados o perfilados (p. ej. económicas plantillas de letras)						Tuschezeichner, Trichterfeder bei speziellem Profil auch Feinmine, minengeführt. *Feinmine, rohgeführt nur bei speziellen Schablonenschlitzbreiten, in seitenrichtiger Schablonenlage. <i>Technical pens, funnel pens; also fine lead pencils, lead guided with some profiles. *Fine lead pencils, tube guided, for a few special line widths, in reading position.</i> Estilógrafo técnico o pluma de embudo. Con bordes especiales, también portamina de mina fina con mina guiadas. *Portamina de mina fina con tubo-guía, únicamente para plantillas con ranuras especiales y en posición normal de la plantilla.
Oberseitige Tuschenoppen in seitenrichtiger Schablonenlage, Standardausführung Zeichenschablone <i>Ink bosses top side</i> in reading position Puntos realizados en el lado superior (en posición normal de plantilla) Ejecución standard para plantillas de dibujo						Füllminenstift und Feinminenstift in seitenrichtiger Schablonenlage, Tuschezeichner in gewendeter Schablonenlage. <i>Clutch pencils, fine lead pencils in reading position, technical pens in upside down position.</i> Portamina automática y portamina de mina fina en posición normal de la plantilla. Estilógrafo técnico en posición inversa de la plantilla.
Unterseitige Tuschenoppen in seitenrichtiger Schablonenlage <i>Ink bosses bottom side</i> in reading position Puntos realizados en el lado inferior (en posición normal de la plantilla)						Tuschezeichner, Feinminenstifte. * = spezielle Schablonenschlitzbreite in richtiger Schablonenlage <i>Technical pens, fine lead pencils; * = for a few special line widths in reading position.</i> Estilógrafo técnico y portaminas de mina fina. *Portamina de mina fina con tubo-guía, únicamente para plantillas con ranuras especiales y en posición normal de la plantilla.
Doppelseitige Tuschenoppen nur bei Kurven und Dreiecken <i>Ink bosses both sides</i> only for curves and set squares Puntos realizados por ambos lados Únicamente para curvas y escuadras						Tuschezeichner, Feinminenstifte in seitenrichtiger und gewendeter Schablonenlage. <i>Technical pens, fine lead pencils in reading and upside down position.</i> Estilógrafo técnico y portaminas de mina fina, tanto en posición normal de la plantilla.
Oberseitige Tuschefacette in seitenrichtiger Schablonenlage <i>Ink facet top side</i> in reading position Bordes biselado en el lado superior en posición normal de la plantilla						Füllminenstift und Feinminenstift in seitenrichtiger Schablonenlage. Tuschezeichner in gewendeter Schablonenlage. <i>Clutch pencils and fine lead pencils in reading position; technical pens in upside down position.</i> Portamina automática y portamina de mina fina en posición normal de la plantilla. Estilógrafo técnico en posición inversa de la plantilla.
Doppelseitige Tuschefacette nur bei Kurvenschablonen und Maßstäben <i>Ink facet both sides</i> only curves and rulers Bordes biselados por ambos lados únicamente para curvas y reglas						Tuschezeichner, Feinminenstifte in seitenrichtiger und gewendeter Schablonenlage. <i>Technical pens, fine lead pencils in reading and upside down position.</i> Estilógrafo técnico y portaminas de mina fina, tanto en posición normal de la plantilla.

Die Tuschezeichner

STANO•PROFESSIONAL: Präzision zeichnet sie aus.

Die normgerechte Zeichnung hängt auch vom Tuschezeichner ab. Deshalb ist für unseren Tuschezeichner STANO•PROFESSIONAL die Norm der absolute Maßstab.

Bei technischen Zeichnungen kommt es auf absolute Präzision an. Diese Präzision garantieren unsere Tuschezeichner. Sie sind High-Tech-Zeichengeräte, die durch schnelles Anschreiben, präzisen Tuschefluß und ein unproblematisches und komfortables Handling überzeugen.

Technical Pens

STANO•PROFESSIONAL: *Precision is their trade mark.*

Being able to produce a draft according to standard also depends on the kind of technical pen that you are using. That is why our technical pen STANO•PROFESSIONAL are made to meet any standard. Technical drafts have to be absolutely precise. This kind of precision is guaranteed by our technical pens. They are high-tech drawing instruments distinguished by their instant action, even flow of ink, and easy, comfortable handling.

Los estilógrafos técnicos

STANO•PROFESSIONAL: Se distinguen por su precisión.

Dibujar según la norma también depende del estilógrafo técnico. Es por ello que la norma es el criterio absoluto para nuestros estilógrafos STANO•PROFESSIONAL. En el dibujo técnico todo depende de una absoluta precisión. Esta precisión la garantizamos en nuestros estilógrafos técnicos. Ambos son instrumentos de dibujo de altísima tecnología, que convencen por su prontitud de utilización, su flujo continuo de la tinta y su manejo cómodo.



Tuschezeichner STANO•PROFESSIONAL

Reihe 1 und Reihe 2 für professionelles technisches Zeichnen, mit hartverchromter Zeichenspitze, komplett mit Halterschaft und Clip. Spitzenschlüssel im Halterschaft.

Technical Pen STANO•PROFESSIONAL

High precision technical pens for professional drafting. With hard-chromium-plated drawing point, complete with barrel and clip. The key for drawing point is mounted inside in barrel.

Estilógrafos STANO•PROFESSIONAL

Serie 1 y Serie 2 para un dibujo técnico profesional, con puntera de cromado duro y completo con mango, clip y llave de tuerca incorporada en el mango.

Tuschezeichner STANO•PROFESSIONAL

Reihe 1 (Isonorm) U III

Reihe 2 (Isonorm) U III

Technical Pen STANO•PROFESSIONAL

Range 1 (Isonorm) U III

Estilógrafos STANO•PROFESSIONAL

Serie 1 (Isonorm) U III

Serie 2 (Isonorm) U III

Serie 3 (Isonorm) U III

Serie 4 (Isonorm) U III

Zeichenspitze STANO•PROFESSIONAL

Reihe 1 (Isonorm) U III

Reihe 2 (Isonorm) U III

Drawing Points STANO•PROFESSIONAL

Range 1 (Isonorm) U III

Range 2 (Isonorm) U III

Punteras STANO•PROFESSIONAL

Serie 1 (Isonorm) U III

Serie 2 (Isonorm) U III

Serie 3 (Isonorm) U III

Serie 4 (Isonorm) U III

0,13
0,18
0,25
0,35
0,50
0,70
1,00
1,40
2,00

DIN 15
DIN 6775
DIN/ISO
9175
ISO 128
ISO 3098
DIN 6776
DIN 16/17

Art.-No.

800013
800018
800025
800035
800050
800070
800100
800140
800200

DIN 15
DIN 6775
DIN/ISO
9175
ISO 128
ISO 3098
DIN 6776
DIN 16/17

820013
820018
820025
820035
820050
820070
820100
820140
820200

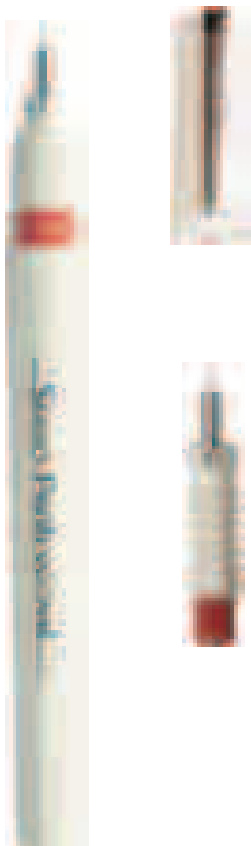

Tuschezeichner STANO • PROFESSIONAL
Reihe 2 U

Technical Pen STANO • PROFESSIONAL
Range 2 U

Estilógrafos STANO • PROFESSIONAL
Serie 2 U

0,10
0,20
0,30
0,40
0,50
0,60
0,80
1,00
1,20

DIN 15
Ausg./
edition
12/67

800001
800002
800003
800004
800005
800006
800008
800010
800012

Zeichenspitze STANO • PROFESSIONAL
Reihe 2 U

Drawing Points STANO • PROFESSIONAL
Range 2 U

Punteras STANO • PROFESSIONAL
Serie 2 U

0,10
0,20
0,30
0,40
0,50
0,60
0,80
1,00
1,20

DIN 15
Ausg./
edition
12/67

820001
820002
820003
820004
820005
820006
820008
820010
820012



60 x 90 mm

Radierschablone, aus ca. 0,1 mm Edelstahlfolie
Eraser shield, made from approx. 0.1 mm of high-grade steel foil
Plantilla de borrar, de acero fino de 0,1 mm

590820



Tuschelöser, Reinigungsflüssigkeit für Tuschezeichner in Kunststoff-Flasche
India Ink Solvent Cleaner, fluid for technical pens, plastic-bottles
Disolvente para estilógrafos, en botella de plástico

100 ml
250 ml

590100
590102

STANO • PROFESSIONAL SETS

Los Estuches de trabajo STANO • PROFESSIONAL

Art.-No.



3er Satz, 0,35/0,50/0,70 mm
Zirkelersatz 4 mm, Zeichentusche 23 ml, in stano•mat-Box

3-pen Set, 0.35/0.50/0.70 mm
compass adapter 4 mm, drawing ink 23 ml, complete with case

Estuche con 3 estilógrafos, 0,35/0,50/0,70 mm
adaptador de compás 4 mm y tinta china 23 ml. Estuche robust.

883170

wie/like/como 883170, jedoch/but/pero 0,10/0,20/0,30
wie/like/como 883170, jedoch/but/pero 0,30/0,40/0,50

883103
883105



3er Satz, 0,10/0,30/0,50
Zirkelersatz 3,5mm, Zeichentusche 23 ml, Radierer,
Feinminenstift 0,5 + Ersatzminen, in Scharnierbox

3-pen Set, 0.10/0.30/0.50
compass adapter 3.5mm, drawing ink 23 ml, eraser, fine lead pencil 0.5
with refills, complete with case

Estuche con 3 estilógrafos, 0,10/0,30/0,50
adaptador de compás 3,5 mm, tinta china 23 ml, goma de borrar,
portamina de mina fina 0,5mm y minas de repuesto. Estuche robust.

883445

wie/like/como 883445, jedoch/but/pero 0,20/0,40/0,60

883446



3er Satz, Tuschezeichner 0,25/0,35/0,50 mm
mit Feinminenstift 0,5 mm + Ersatzminen, Zirkelersatz 4mm,
Radierer und Zeichentusche 23 ml,

3-pen Set, Technical pen 0.25/0.35/0.50 mm
with fine lead pencil 0.5 mm and refills, compass adapter 4mm,
eraser and drawing ink 23 ml

Estuche con 3 estilógrafos,
Estilógrafos 0,25/0,35/0,50 mm
con portamina de mina fina 0,5 y minas de repuesto, adaptador
de compás 4 mm, goma de borrar y tinta china 23 ml.

883449

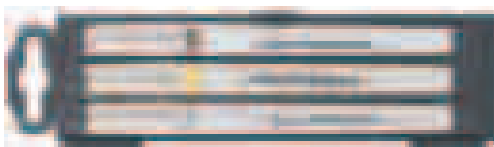

3er Satz
Tuschezeichner 0,25/0,35/0,50 mm

3-pen Set
Technical pen 0.25/0.35/0.5 mm

Estuche con 3 estilógrafos
0,25/0,35/0,50 mm

883450



4er Satz, Tuschezeichner 0,25/0,35/0,50/0,70 mm
mit Feinminenstift 0,5 mm + Ersatzminen, Zirkelersatz 4 mm,
Radierer und Zeichentusche 23 ml,

4-pen Set, Technical pen 0.25/0.35/0.50/0.70 mm
with fine lead pencil 0.5 mm and refills, compass adapter 4 mm,
eraser and drawing ink 23 ml

Estuche con 4 estilógrafos,
Estilógrafos 0,25/0,35/0,50/0,70 mm
con portamina de mina fina 0,5 mm + minas de repuesto, adaptador
de compás 4 mm, goma de borrar y tinta china 23 ml.

884469

STANO•PROFESSIONAL SETS

Los Estuches de trabajo STANO•PROFESSIONAL

Art.-No.



4er Satz
Tuschezeichner 0,25/0,35/0,50/0,70 \bar{m}

4 pen Set
Technical pen 0,25/0,35/0,50/0,70 \bar{m}

Estuche con 4 estilógrafos
0,25/0,35/0,50/0,70 \bar{m}

884470



4er Satz stano•mat, 0,25/0,35/0,50/0,70 \bar{m}
mit Feuchthalteelement, Zirkeleinsatz 4mm, Gelenkstück und
Zeichentusche 23 ml, in stano•mat Box

4-pen Set stano•mat, 0,25/0,35/0,50/0,70 \bar{m}
with humidifier, adjustable joint, compass adapter 4mm and
drawing ink 23 ml, complete with case

Estuche stano•mat con 4 estilógrafos,
0,25/0,35/0,50/0,70 \bar{m}
con elemento humedecedor, pieza articulada, adaptador de
compás 4 mm y tinta china 23 ml.

884003

wie 884003 jedoch Tuschezeichner 0,20/0,30/0,40/0,50
description as 884003 but technical pens 0,20/0,30/0,40/0,50
descripción como 884003 pero estilógrafos 0,20/0,30/0,40/0,50

884007



4er Satz, 0,25/0,35/0,50/0,70 \bar{m}
Zirkeleinsatz 4mm und Zeichentusche 23 ml, in Box

4-pen Set, 0,25/0,35/0,50/0,70 \bar{m}
compass adapter 4mm and drawing ink 23 ml, complete with case

Estuche con 4 estilógrafos,
0,25/0,35/0,50/0,70 \bar{m}
con adaptador de compás 4 mm y tinta china 23 ml.

884170

wie 884170 jedoch Tuschezeichner 0,20/0,30/0,40/0,50
description as 884170 but technical pens 0,20/0,30/0,40/0,50
descripción como 884170 pero estilógrafos 0,20/0,30/0,40/0,50

884107

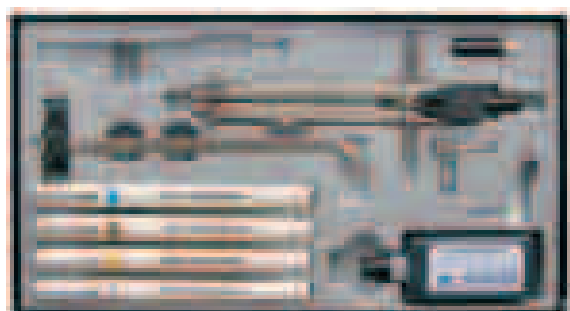

4er Satz, 0,25/0,35/0,50/0,70 \bar{m}
mit Schnellverstellzirkel, Verlängerungsstange, Zirkeleinsatz 4mm,
Minendose, Zeichentusche 23 ml, in Scharnierbox

4-pen Set, 0,25/0,35/0,50/0,70 \bar{m}
with adjusting compass, extension bar, compass adapter 4mm,
box for lead refills and drawing ink 23 ml, complete with case

Estuche con 4 estilógrafos,
0,25/0,35/0,50/0,70 \bar{m} con compás de ajuste rápido, alargadera,
adaptador de compás 4 mm, minas de repuesto y tinta china 23 ml.
Estuche robusto

880417

wie 880417 jedoch Tuschezeichner 0,20/0,30/0,40/0,50
description as 880417 but technical pens 0,20/0,30/0,40/0,50
descripción como 880417 pero estilógrafos 0,20/0,30/0,40/0,50

880418

STANO • PROFESSIONAL SETS

Los Estuches de trabajo STANO • PROFESSIONAL

Art.-No.

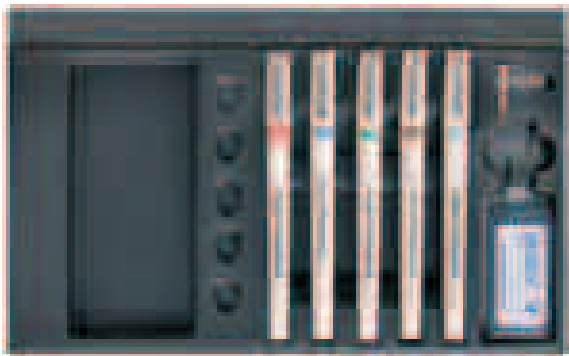

5er Satz, 0,20/0,30/0,40/0,50/0,80
Zirkelleinsatz 4mm, Zeichentusche 23 ml, im Etui

5-pen Set, 0,20/0,30/0,40/0,50/0,80
compass adapter 4mm, drawing ink 23 ml, complete with case

Estuche con 5 estilógrafos, 0,20/0,30/0,40/0,50/0,80
adaptador de compás 4 mm y tinta china 23 ml. Estuche robusto

885107

7er Satz, 0,10/0,20/0,30/0,40/0,50/0,80/1,2
Zirkelleinsatz 4mm, Zeichentusche 23 ml, im Etui

7-pen Set, 0,10/0,20/0,30/0,40/0,50/0,80/1,2
compass adapter 4mm, drawing ink 23 ml, complete with case

Estuche con 7 estilógrafos,
0,10/0,20/0,30/0,40/0,50/0,80/1,2
adaptador de compás 4 mm y tinta china 23 ml. Estuche robusto

888107

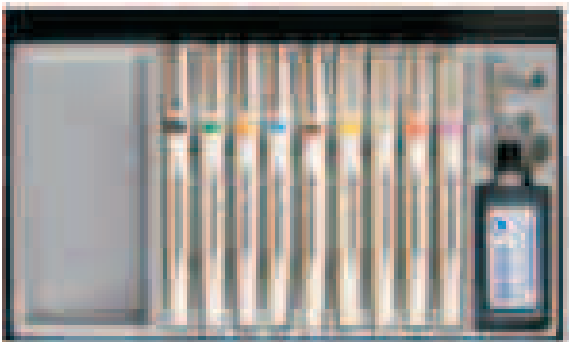

9er Satz, 0,13/0,18/0,25/0,35/0,50/0,70/1,0/1,4/2,0 \bar{m}
Zirkelleinsatz 4 mm, Zeichentusche 23 ml, im Etui

9-pen Set, 0,13/0,18/0,25/0,35/0,50/0,70/1,0/1,4/2,0 \bar{m}
compass adapter 4 mm, drawing ink 23 ml, complete with case

Estuche con 9 estilógrafos,
0,13/0,18/0,25/0,35/0,50/0,70/1,0/1,4/2,0 \bar{m}
adaptador de compás 4 mm, tinta china 23 ml, Estuche robust.

889109

wie/like/como 889109, jedoch/but/pero
0,10/0,20/0,30/0,40/0,50/0,60/0,80/1,0/1,2

889107



Gelenkstück für schräge Schreibhaltung von Tuschezeichner
Adjustable joint for technical pens, to achieve an oblique drawing position.
Pieza articulada para estilógrafos, para conseguir una posición de dibujo oblicua.

570001



Zirkelleinsatz mit Zapfendurchmesser 3,5 oder 4 mm
Compass attachment with shank diameters 3.5 or 4 mm.
Adaptadores para compás con diámetro del pivote 3,5 ó 4 mm
Packungseinheit 5 Stück/packing unit 5 pcs/Unidad de embalaje 5 un.

Ø 3,5 mm
Ø 4,0 mm

570135
570140



Universal-Zirkelleinsatz. Einsatzzapfen 3,5 und 4 mm
Für alle Schreib- und Zeichengeräte mit unterschiedlichen Längen,
Höhen und Durchmessern verwendbar.
*Universal compass attachment. Shank diameters 3.5 and 4 mm
Compatible with writing and drawing instruments of different length,
heights and diameters.*

570160

Adaptadores universal para compás. Diámetro del pivote 3,5 y 4 mm.
Para todos instrumentos de dibujo y escritura, con distintos diámetros
hasta 12 mm

STANO TEC FINELINER TINTE, INDIAN INK, TINTAS

stano tec fineliner

Faserschreiber mit metallgefaster Spitze für exaktes Schreiben.
Tiefschwarze Tinte sorgt für gute Zeichenergebnisse.

stano tec fineliner

Fine felt-tip pen with metal-calm point for exact writing.
Deep black ink provides for good sign results.

stano tec fineliner

Estilógrafo con punta fina de felpa para escritura exacta.
La tinta negra intensa asegura unos resultados perfectos.

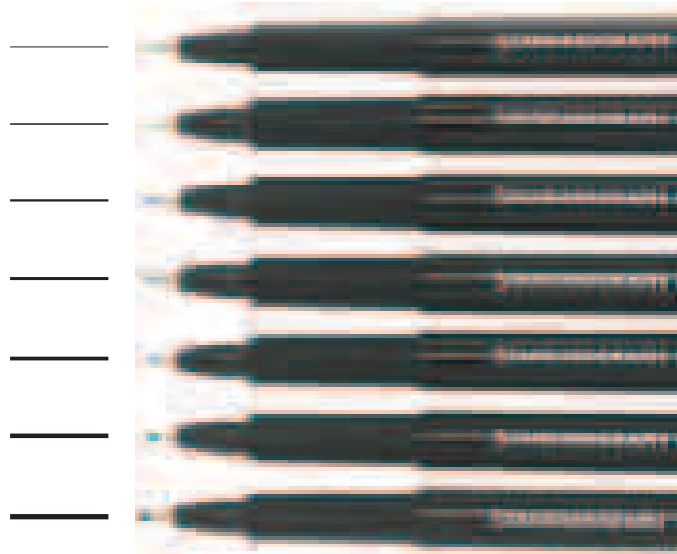

0,1	0,2	0,3	0,4	0,5	0,6	0,7	0,8	Set 1-5-8	Set 1-3-5-7	Set 1-3-5-6-8	Set 1-3-5-6-7-8
574401	574402	574403	574404	574405	574406	574407	574408	574443	574444	574445	574446



Tusche (nicht anlösend) für Zeichenkarton, Transparentpapier und mattierte Zeichenfolie
Indian ink (non-solvent) for drawing on carton, transparent paper and mat film
 Tusche (non corrosivas) para cartulina de dibujo, papel transparente y poliéster mateado

23 ml schwarz black negro	250 ml schwarz black negro	1.000 ml schwarz black negro	23 ml rot red rojo	23 ml grün green verde	23 ml blau blue azull	23 ml gelb yellow amarillo	23 ml braun brown marrón	23 ml violett violett violeta	23 ml orange orange naranja	23 ml weiß white blanco
550201	550501	550801	550202	550203	550204	550205	550206	550207	550208	550209

Trichterfedern / Funnel pens / Plumas de embudo

Art.-No.



Trichterfedern Reihe 1 und Reihe 2 mit Tuschestufe
für Linienbreiten nach DIN 15 Ausg. 12.67 sowie ISO 128

*Funnel pens with ink step, range 1 and range 2
for line widths according DIN 15 ed. 12.67 as well as ISO 128*

Plumas de embudo con escalón, Serie 1 y Serie 2
para anchos de líneas en norma DIN 15 edición 12.67 así como ISO 128

Linienbreite / line width ancho de líneas	US-Code
⌋ 0,18 mm \bar{m}	4 x 0
⌋ 0,25 mm \bar{m}	3 x 0
⌋ 0,30 mm	00
⌋ 0,35 mm \bar{m}	0
⌋ 0,45 mm	1
⌋ 0,50 mm \bar{m}	2
⌋ 0,70 mm \bar{m}	2,5
⌋ 0,80 mm	3
⌋ 1,00 mm \bar{m}	3,5
⌋ 1,20 mm	4
⌋ 1,40 mm \bar{m}	5
⌋ 2,00 mm \bar{m}	6

DIN 15
Reihe 1 u. 2
Ausg./
edition
12/67
ISO 128

400018
400025
400003
400035
400045
400050
400070
400008
400100
400012
400140
400200



Trichterfedern mit Planröhrchen, für Linienbreiten nach DIN 1451
Funnel pens with plane tubes, for line widths according to DIN 1451

Plumas de embudo con tubito de fondo plano
para achuras de línea según DIN 1451

Linienbreite / line width ancho de líneas	US-Code
⌋ 0,25 mm	51
⌋ 0,35 mm	52
⌋ 0,45 mm	53
⌋ 0,55 mm	54
⌋ 0,70 mm	55
⌋ 0,80 mm	56
⌋ 1,00 mm	57
⌋ 1,25 mm	58
⌋ 1,50 mm	510
⌋ 1,70 mm	512
⌋ 2,00 mm	514
⌋ 2,50 mm	516
⌋ 3,50 mm	525

DIN 1451

400051
400052
400053
400054
400055
400056
400057
400058
400510
400512
400514
400516
400528

Zubehör für Trichterfedern/Accessories for Funnel Pens/Accesorios para plumas de embudo



Schreibhalter mit verstellbarer Federhalterung und Stützklemme

Penholder with linked grip element and snap-on support

Mango portador con portaplumas ajustable y soporte de apoyo

440044

Sützklemme für Schreibhalter, 10 Stück im Cellophanbeutel

Square supporting clips 10 pcs in a cellophane bag

Garra de detención 10 unid. en bolsa de celofán

440045

Beschriftungssystem stano•script

Das stano•script Beschriftungssystem von STANDARDGRAPH ist eine universelle Beschriftungsmethode für alle Bereiche der Technik, Vermessung und Gebrauchsgraphik. Tastschreiber, Schriftschablonen und Tuschefüller - als Ersatz auch Trichterfedern und Bleimineneinsatz - sind die Grundelemente.

Zusammen mit dem Zubehör ist alles in modernen stabilen Etuis aufgehoben.

Lettering System stano•script

The stano•script-lettering system of STANDARDGRAPH is a universal lettering method for all branches of engineering, surveying and graphics. Scriber, lettering guide and technical pen - as a substitutes funnel pens and lead-pencil insets - are the basic elements. They are kept clearly arranged together with the accessories in sturdy professional cases.

El sistema de rotulación stano•script

El sistema de rotulación stano•script de STANDARDGRAPH es un método universal de rotulación para todos los ramos de la técnica, geodesía y gráfica utilitaria. Sus elementos básicos son el aparato trazador (cangrejo/araña) el rotulador y la estilográfica de tinta china - como reemplazo también la plumilla metálica o el portalápiz.

Junto con los accesorios se encuentra todo claramente en estuches modernos y fuertes.

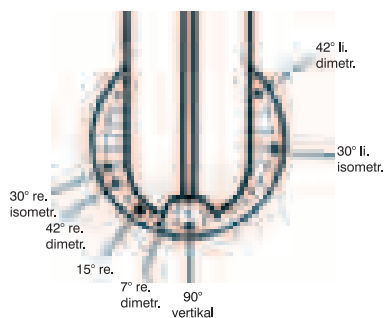

stano•script Scriber Beschriftungsgerät komplett

stano•script Scriber Complete Lettering Instrument

CANREJO/ARAÑA stano•script Aparato completo de rotulación

Scriber-Ersatzteile / Scriber spare parts / Piezas de recambio

Spurstift	track controll pin	Clavija de guía
Taststift	tracer	Clavija palpadora
Dose mit 5 Ersatzminen	box with 5 spare leads	Cajita con 5 minas de recambio
Bleiminien-Einsatz	lead insert	El portalápiz
Minenspitzer	lead sharpener	Sacapuntas

Art.-No.

5000

5020
5021
5023
5024
5025

stano•script - Arbeitssätze mit Amerikanischer Standardschrift

stano•script - Work Sets with american standard lettering

stano•script - Frases de trabajo con la letra de estándar americana

Art.-No.



Schriftschab. / lettering guides
Plantillas de letras

Tuschezeichner / technical pen
estilógrafos

60/1.5		U 0,18/4 x 0
80/2.0		U 0,25/3 x 0
100/2.5	6er-Set	U 0,30/00
120/3		U 0,35/0
140/3.5		U 0,45/1
175/4.5		U 0,50/2
200/5		U 0,70/2,5
240/6		U 0,80/3
290/7.5		U 1,00/3,5
350/9		U 1,20/4
425/11		U 1,40/5
500/12.5		U 2,00/6

Zubehör: Scriber No. 5000, Tusche 23 ml, Bleimineneinsatz, Minendose, Minenspitzer, Schreibhalter, stano•mat-Feuchthalteelement sowie Schablonen, Tuschezeichner lt. Liste, Trichterfedern - Linienbreite wie Tuschezeichner

Accessories: scriber no. 5000, ink 23 ml, lead-pencil inset, box with spare leads, lead sharpener, pen holder, stano•mat-humidifier and lettering guides, technical pens according to list, funnel pens - line width like technical pens.

Accesorios: Cangrejo no. 5000, 23 ml de tinta china, portaminas, minas de recambio, Sacapuntas, Mango portador, humedecedor stano•mat, plantillas de letras, estilógrafos de tinta china y plumas de embudo según la lista

6er Satz,

Inhalt wie beschrieben, zusätzlich Trichterfeder 1,0/3,5 und 1,2/4, ohne Minenspitzer

6 piece set

Contents as described, in addition funnel pen 1,0/3,5 and 1,2 / 4 without mine sharpener

6ta frasa

Contenido como de modo descrito, además la pluma de embudo 1,0/3,5 und 1,2 / 4 sin sacapuntas de minas

5306

12er Satz

Inhalt wie beschrieben, statt Linienbreite 0,8/3 -Linienbreite 2,5/7

12 piece set

Contents as described, instead of line width 0,8/3 - line width 2,5/7

12ta frasa

Contenido como de modo descrito, en vez del ancho de líneas 0,8/3 - el ancho de líneas 2,5/7

5312



ABCD

"stano•script" Schriftschablonen, Amerikanische Standardschrift

"stano•script" lettering guides, American standard

Las regletas individuales "stano•script", Letras americanas standard

stano•script-Tuschezeichner

STANO•PROFESSIONAL jedoch mit Kurzhalterschaft

stano•script Technical Pen

STANO•PROFESSIONAL however with short barrel

Los estilógrafos de tinta china

stano•script con cuerpo corto

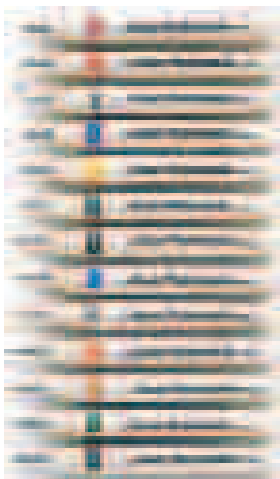

Schriftgröße mm/Lettering size

Tuschezeichner/Pen

US-Code

50/1,3	5203/050	U 0,13	5 x 0	545013
60/1.5	5203/060	U 0,18	4 x 0	545018
80/2.0/080	U 0,25	3 x 0	545025
100/2.5/100	U 0,30	00	545030
120/3/120	U 0,35	0	545035
140/3.5/140	U 0,45	1	545045
175/4.5/175	U 0,50	2	545050
200/5/200	U 0,70	2,5	545070
240/6/240	U 0,80	3	545080
290/7.5/290	U 1,00	3,5	545100
350/9/350	U 1,20	4	545120
425/11/425	U 1,40	5	545140
500/12.5/500	U 2,00	6	545200

"Miniclip" Skizzierstifte "Miniclip" Sketch pens Portaminas "Miniclip"

Art.-No.



silber/silver/argentado

571510

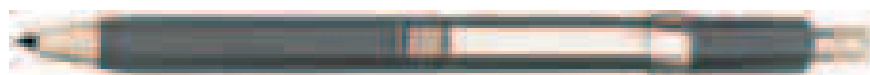

schwarz/black/negro

571511

Skizzierstift "Miniclip" mit Clip und Spitzer, Mine 2 mm
 Sketch pen "Miniclip" with clip and sharpener, lead 2 mm
 Portamina "Miniclip" para minas 2 mm, con clip y sacapuntas
 10 Stück im Karton/1 carton incl. 10 pcs./10 piezas en cartón



Display 24 Stück/Display 24 pcs/24 pz en exhibitor

silber/silver/argentado

schwarz/black/negro

571510-24

571511-24



silber & schwarz
 silver & black
 argentado y negro

571510-11/24



rot/red/rojo

571530



blau/blue/azul

571531



grün/green/verde

571532



gelb/yellow/
 amarillo

571533

Skizzierstift "Miniclip" mit Clip und Spitzer, Mine 2 mm
 Sketch pen "Miniclip" with clip and sharpener, lead 2 mm
 Portamina "Miniclip" para minas 2 mm, con clip y sacapuntas
 10 Stück im Karton/1 carton incl. 10 pcs./10 piezas en cartón



Display 24 Stück/Display 24 pcs/
 24 pz en exhibitor

farbig sortiert
 assorted colours
 colores clasificados

571539

Skizzierstifte

Sketch pens

Portaminas

Art.-No.



Skizzierstift "Grado" schwarz
mit Clip und Spitzer, Mine 2 mm,
einstellbare Skala für Härtegrade

*Sketch pen "Grado" black
with clip and sharpener, lead 2 mm,
adjustable scale for graduation*

Portamina "Grado" negro
para minas 2 mm, con clip y sacapuntas

10 Stück im Karton/1 carton incl. 10 pcs./10 piezas en cartón

Display mit 24 Stück
Display with 24 pcs
Exhibitor con 24 un.



CC-21002SC-24

6 Stück im Röhrchen/6 pcs in small tube/6 piezas en el tubito

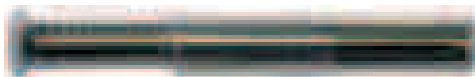

Ersatzminen 2,0 mm HB
Refill 2.0 mm HB
Mina de recambio 2,0 mm HB

573010HB



Dosen-Minenspitzer
für Minen 2,0 mm

*Box sharpener
for leads 2.0 mm*

Sacapuntas de botes
para minas 2,0 mm

Display mit 20 Stück
Display 20 pcs
20 pz en exhibitor



DX3250

Feinminenstifte

Mechanical Pencils

Portaminas de mina fina

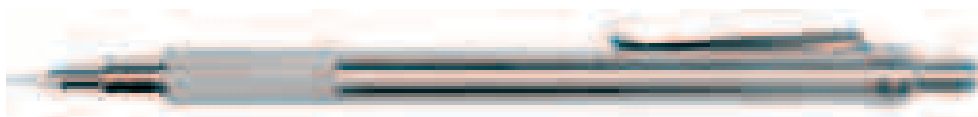

Feinminenstift chrom 0,5 mm
mit Radiergummi, Schaft und Clip aus Metall,
Doppeldruckmechanik

*Mechanical pencil chrome 0.5 mm
with eraser, metal barrel and clip, retractable
guide tube.*

Portamina de mina fina 0,5 mm
con goma, mango y clip de metal, punta
retractil.

571421

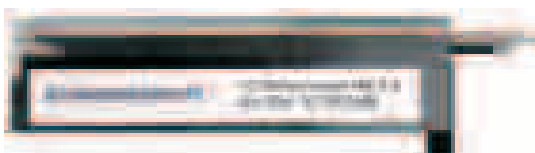

Feinstrichminen 0,5 mm HB
fine leads 0.5 mm HB
Mina fina 0,5 HB

573002HB

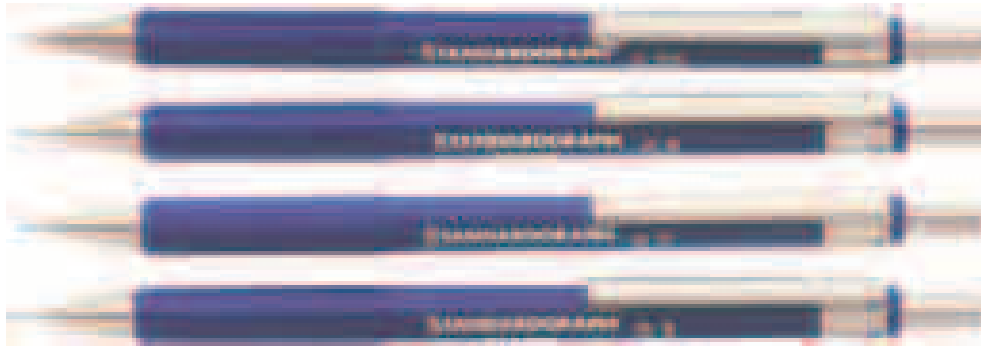

Feinminenstift mit Metallclip und Radiergummi

Mechanical pencil with metal clip and eraser

Portamina de mina fina con clip metal y goma

0,35 mm Mine

0.35 mm lead

0,35 mm minas

0,5 mm Mine

0.5 mm lead

0,5 mm minas

0,7 mm Mine

0.7 mm lead

0,7 mm minas

0,9 mm Mine

0.9 mm lead

0,9 mm minas

Packungseinheit 10 Stück/packing unit 10 pcs/Unidad de embalaje 10 un.

571403

571405

571407

571409



Set Feinminenstifte
0,35 - 0,5 - 0,7 mm
in Plastiktasche

Set mechanical pencils
0.35 - 0.5 - 0.7 mm
in a plastic bag

Set portamina de mina fina
0,35 - 0,5 - 0,7 mm
en bolsa

571422

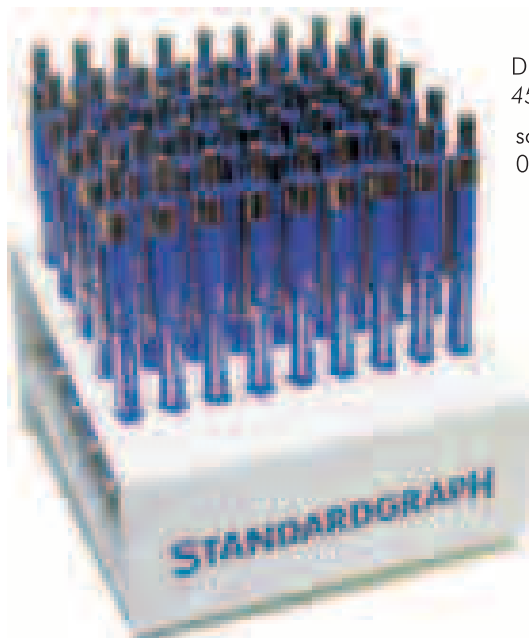

Display mit 45 Stück/Display with 45 pcs/
45 pz en exhibitor
sortiert/assorted/separar
0,35 - 0,5 - 0,7 mm

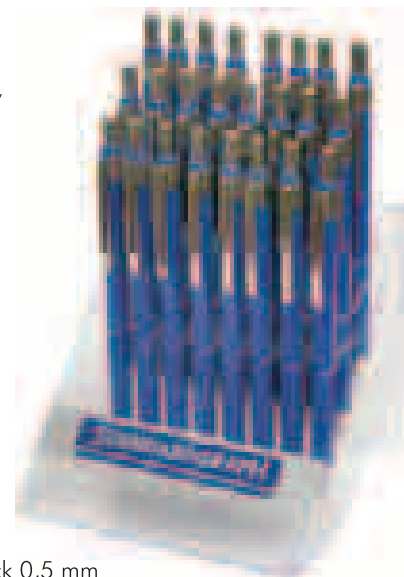

Display mit 24 Stück 0,5 mm
Display with 24 pcs 0.5 mm
Exhibitor con 24 un. 0,5 mm

571430

571405-24

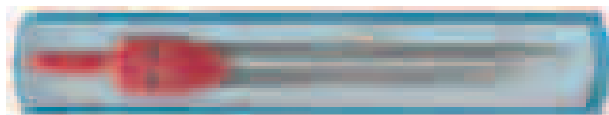

Einsatzzirkel 90 mm, Schenkel nicht knickbar, Box-Deckel mit Lineal, Box farbig sortiert
 Compass 90 mm, without knuckle joint, box cover with ruler, assorted colours box
 Compás de puntas intercambiables 90 mm sin articulaciones, tapa del estuche con regla, parte superior de colores surtidos

571000

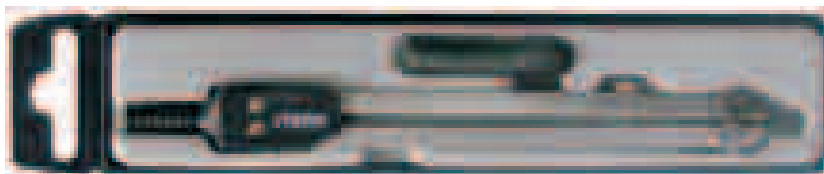

Einsatzzirkel 140 mm, 1 knickbares Gelenk, Minendose, Klarsichtetui
 Compass 140 mm, 1 knuckle joint, box for spare leads, see-through box
 Compás de puntas intercambiables 140 mm con 1 articulaciones, tubito de minas, estuche transparente

571004

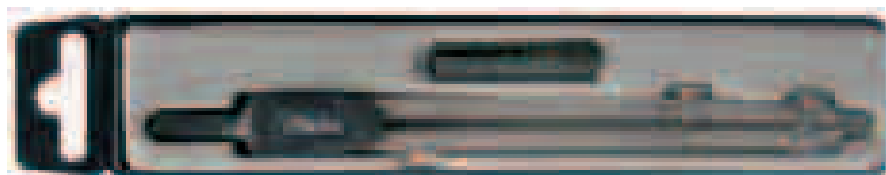

Einsatzzirkel 140 mm, Teleskopverlängerung, 1 knickbares Gelenk, geeignet für Zirkeleinsatz 3,5 mm, Minendose, Klarsichtetui
 Compass 140 mm, telescopic extension, 1 knuckle joint, for compass adapter 3.5 mm, box for spare leads, see-through box
 Compás de puntas intercambiables 140 mm, con alargadana incorporada, con 1 articulaciones, para adaptor 3,5 mm, tubito de minas, estuche transparente

571008



Geometrie-Zirkel 165 mm, Kreise bis 320 mm, Minendose, Klarsichtetui
 Geometry compass 165 mm, circles up to 320 mm, box for spare leads, see-through box
 Compás micrométrico 165 mm, para círculos hasta 320 mm, con tubito de minas, estuche transparente

571010



Großer Teilzirkel 165 mm, Kreise bis 320 mm, 2 knickbare Gelenke, geeignet für Zirkeleinsatz 4 mm, Minendose, Klarsichtetui
 Larger Divider 165 mm, circles up to 320 mm, 2 knuckle joints, for adapter 4 mm, box for spare leads, see-through box
 Gran compás divisor 165 mm, para círculos hasta 320 mm, con 2 articulaciones, para adaptor 4mm, tubito de minas, estuche transparente

571012



Schul-Reisszeug 7-teilig, im Klarsichttui
Mathematical set for students, 7 components, in see-through box
 Compás set scolar con 7 piezas, estuche transparente

571066

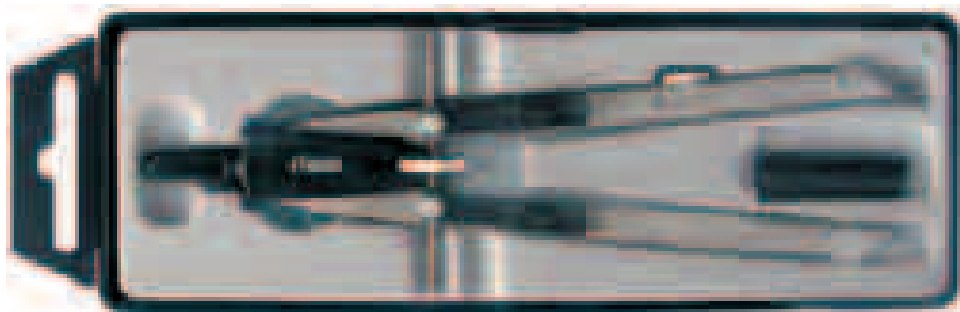

Schnellverstellzirkel 170 mm, Hebelmechanik, Kreise bis 370 mm, 2 knickbare Gelenke,
 geeignet für Zirkeleinsatz 4 mm, Minendose, Klarsichttui

*Quick-setting compass 170 mm, mechanical lever, circles up to 370 mm,
 2 knuckle joints, for adapter 4 mm, box for spare leads, see-through box*

Compás de ajuste rápido por palancas 170 mm, para círculos hasta 370 mm,
 con 2 articulaciones, para adaptor 4mm, tubito de minas, estuche transparente

571020



Schnellverstellzirkel wie 571020, jedoch mit Verlängerungsstange, Kreise bis 620 mm
Quick-setting compass as far as ref. 571020, but with lengthening bar, circles up to 620 mm,
 Compás de ajuste rápido por palancas, idéntico al ref. 571020, pero con alargadera,
 para círculos hasta 620 mm

571024

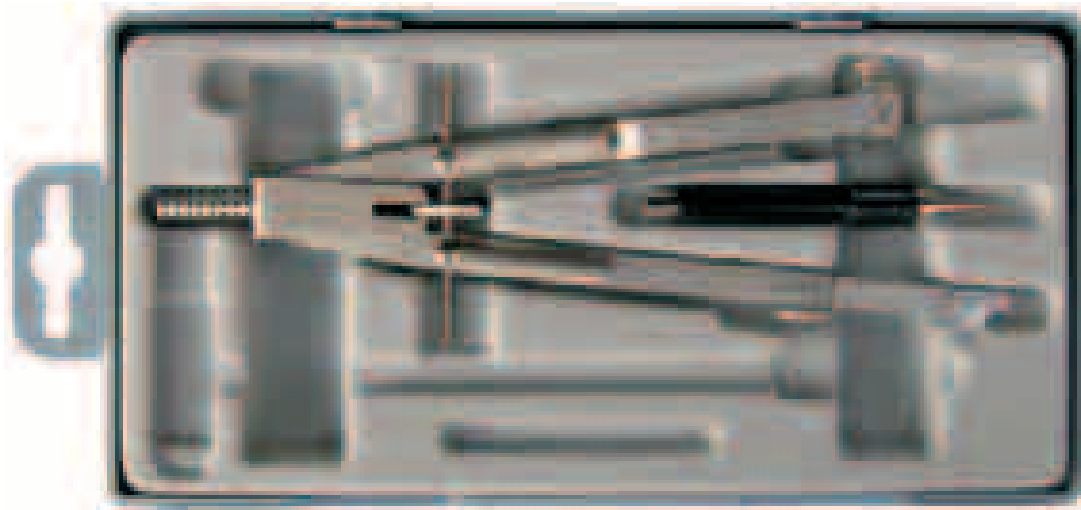

Schnellverstellzirkel 180 mm, Tuschezeichnergabel, Kreise bis 420 mm, 1 Gelenk knickbar, geeignet für Zirkeleinsatz 4 mm, Feinmineneinsatz 0,5 mm, Klarsichttui

Quick-setting compass 180 mm, technical pen adapter, circles up to 420 mm, 1 knuckle joint, for adapter 4 mm, fine lead holder 0.5 mm, see-through box

Compás de ajuste rápido 180 mm, dispositiva para estillógrafos técnicos y portaminas, para círculos hasta 420 mm, con 1 articulación, para adaptor 4mm, estuche transparente

571028



Schnellverstellzirkel wie Art. 571028, jedoch mit Verlängerungsstange 150 mm
Quick-setting compass as far as ref. 571028, but with lengthening bar 150 mm
 Compás de ajuste rápido, identico art. 571028 pero con alargadera 150 mm

571028/S

Feinmineneinsatz für Zirkel
 Lead insert for compasses
 Uso de Portaminas para el compás

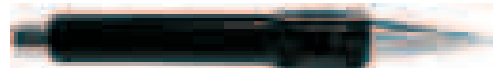

571028FM-E

Verlängerungsstange 150 mm im Klarsichttui
 Extention bar 150 mm, see-through-box
 Alargadera 150 mm, estuche transparente



571050

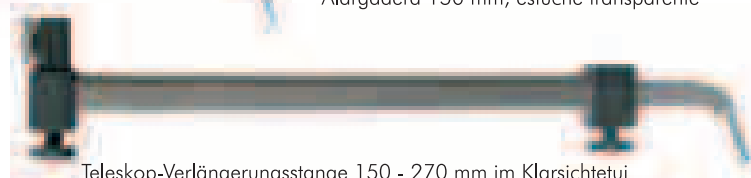

Teleskop-Verlängerungsstange 150 - 270 mm im Klarsichttui
 Telescopic-extention bar 150 - 270mm, see-through-box
 Alargadera telescópica 150 - 270 mm, estuche transparente

571051

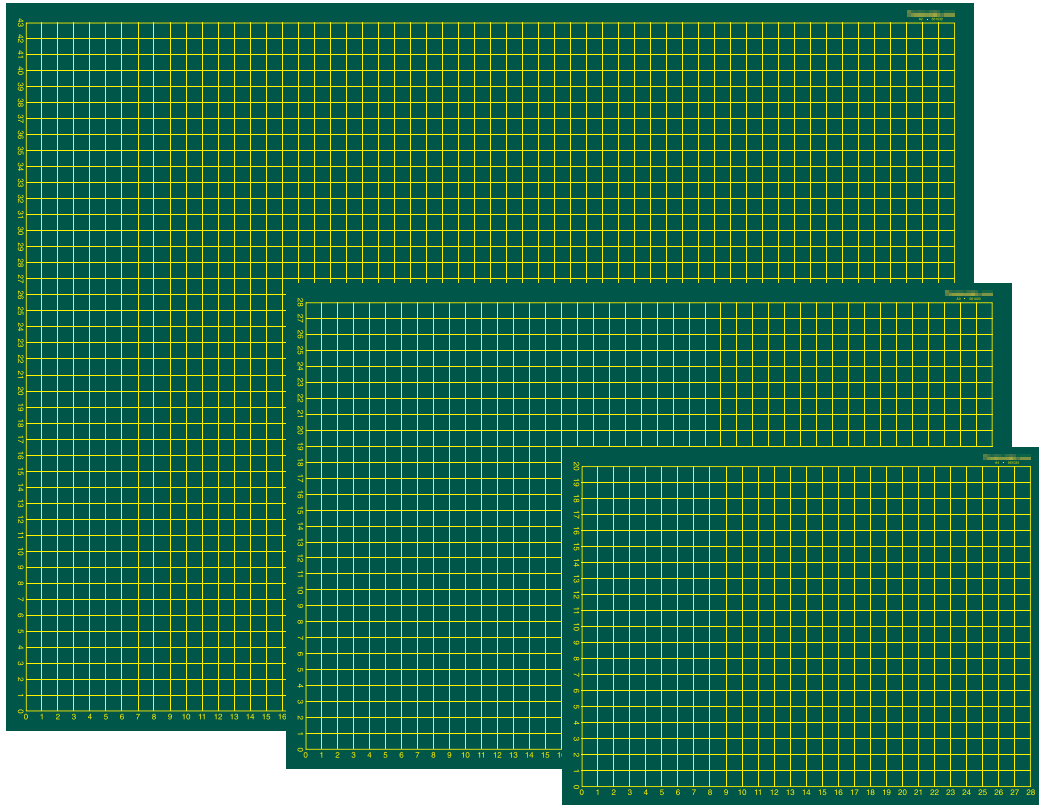

Schneidematte extra stark

3 mm dick, 5 Lagen
 600 x 450 mm (A2)
 450 x 300 mm (A3)
 300 x 220 mm (A4)

Cutting mats extra strong

thickness 3 mm, 5 layers
 600 x 450 mm (A2)
 450 x 300 mm (A3)
 300 x 220 mm (A4)

Tapices de cortemuy resistentes

espesor 3 mm, 5 copas
 600 x 450 mm (A2)
 450 x 300 mm (A3)
 300 x 220 mm (A4)

561032
 561032
 561033

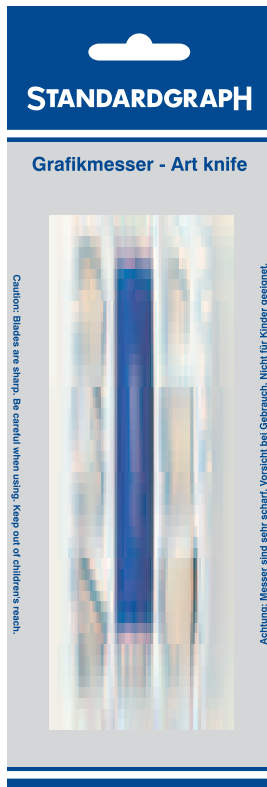

Halter mit 6 Messer
 Handle with 6 blades
 Mango con 6 cuchillos

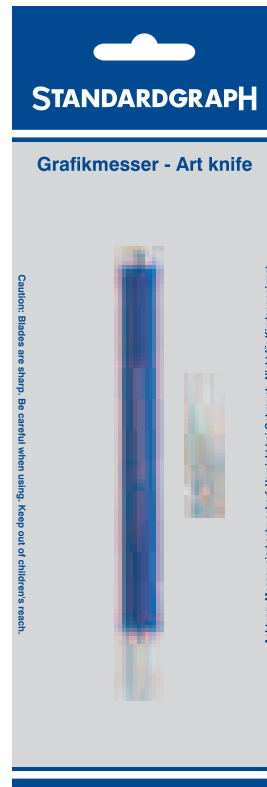

Halter mit 1 Messer
 Handle with 1 blade
 Mango con 1 cuchilla

6 Messer
 1 Messer

561001
 561002

Klebebänder

Adhesive tapes

Cintas adhesivas



Doppelseitige Klebebänder
 Double sided adhesive tapes
 Cinta de doble adhesiva
 Rolle/tape role/argadijo - 33 m

permanent	12 mm	TG11012
permanent	19 mm	TG11019
permanente	25 mm	TG11025
ablösbar	12 mm	TG12012
removable	19 mm	TG12019
no permanente	25 mm	TG12025
permanent/ablösbar	12 mm	TG13012
permanent/removable	19 mm	TG13019
permanente/no permanente	25 mm	TG13025

Spitzer

Sharpeners

Sacapuntas



Display mit 24 Stück

Display with 24 pcs

Display con 24 pz

DX5307



Display mit 24 Stück

Display with 24 pcs

Display con 24 pz

DX5807

Spitzer

Sharpeners

Sacapuntas



Hochwertiger Farb- und Bleistiftspitzer aus Leichtmetall, blockförmig
20 Stück im Karton

*High quality pencil and crayon sharpener made of light metal, block-shaped
20 pcs packed*

Sacapuntas de gran valor del metal ligero, con forma de bloque
20 piezas en el cartón.



DX1122

Keilspitzer aus massivem, ultraharten Kunststoff
Display mit 32 Stück

*Wedge-shaped sharpener made of solid, extra hard plastic
Display with 32 pcs*

Sacapuntas cuneiforme de lo masivo, plástico ultraduro
Display con 32 piezas

DX1230



Verstellbarer Farb- und Bleistiftspitzer aus Messing
im Echtlederetui, einstellbar für 3 Linienbreiten, farblos schutzlackiert
10 Stück im Karton

*Adjustable pencil and crayon sharpener made of brass
in a genuine leather case, adjustable for 3 different lines, transparent baffle varnish
10 pcs in paperbox*

Sacapuntas ajustable del latón.
en el estuche de cuero real, variable para 3 anchos de líneas, incoloro lacado
10 piezas en el cartón

DX4322



Dosenspitzer ,
in transparenten Farben
10 Stück im Karton

*Box sharpener, in clear colours
10 pcs in a carton assorted*

Sacapuntas de botes,
en colores transparentes
10 piezas en el cartón

DX1230

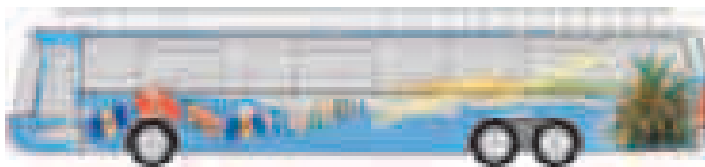
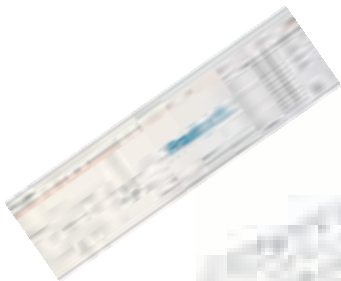

Lineale und Schablonen aus Kunststoff oder Aluminium in Sonderanfertigung

Rulers and templates made of plastic or aluminium in special manufacturing

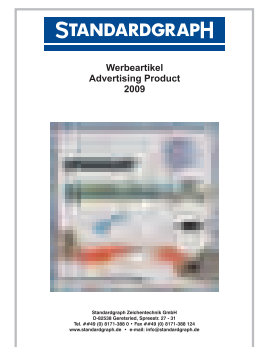

mehr in unserem Werbemittelkatalog
more in our advertising products catalogue



DUX Präzisionsspitzer



Fisher Space Pen



Mappen & Taschen

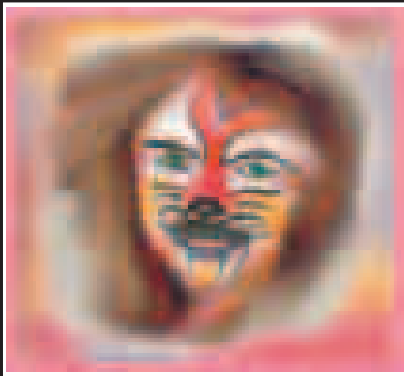

Schminken



Standardgraph Schreibgeräte



Daniel Hechter Schreibgeräte



Monteverde Schreibgeräte

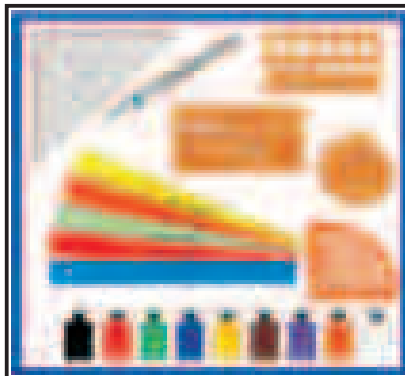

Zeichnen & Konstruieren

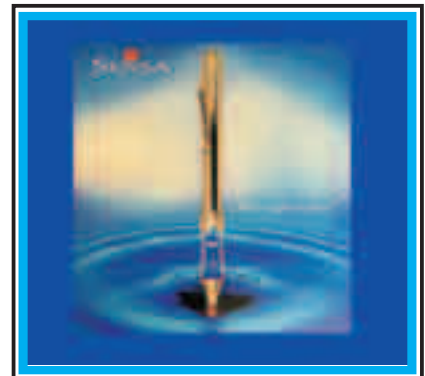

Sensa Schreibgeräte



Retro Schreibgeräte

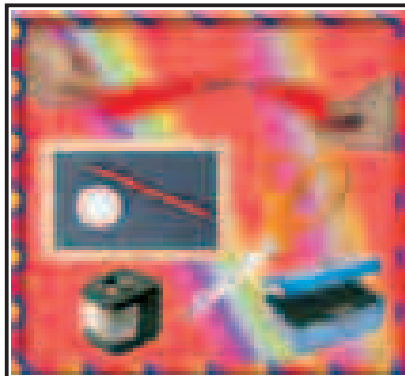

Office

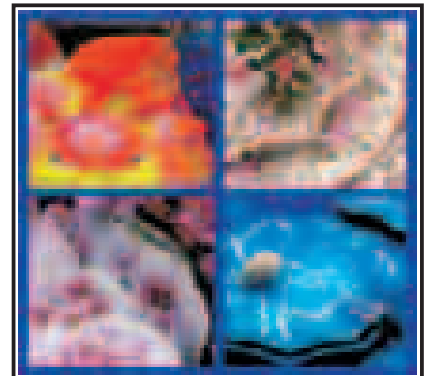

Partygeschirr



Rubinato

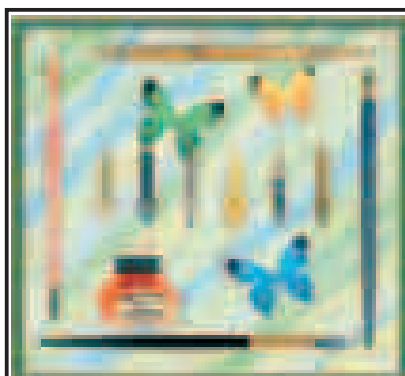

Kalligraphie

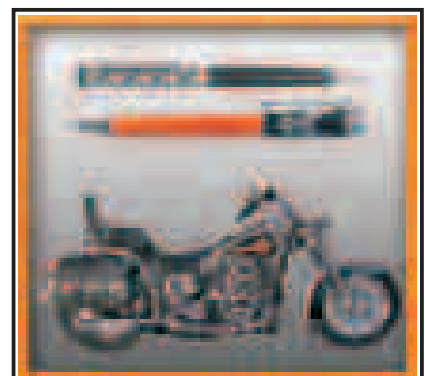

Harley-Davidson